

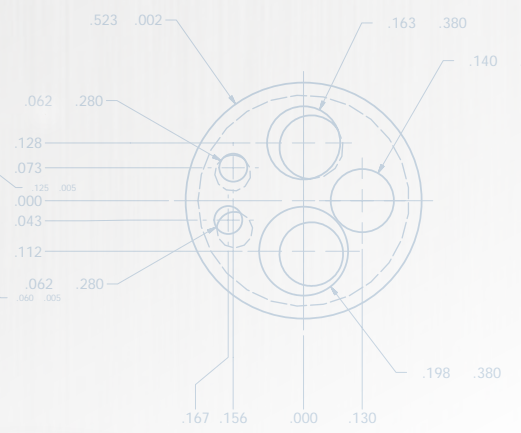

FreelinWade
A COILHOSE COMPANY

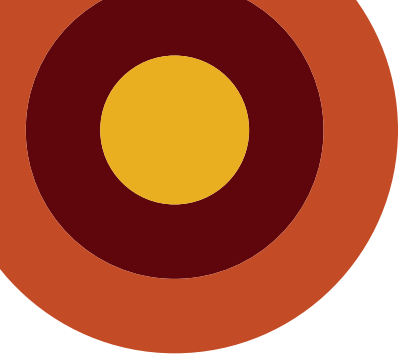



Freelin-Wade® Company sets the standard for quality plastic tubing. All of our tubing is extruded in the USA. Combined with our industry leading manufacturing expertise, rapid delivery, limitless product variations, and value added services, we can meet any of your plastic tubing requirements. Our customer service team is ready to help you find exactly the right tubing solution for your project. Find out how easy it is to do business with Freelin-Wade. Check us out online or call us today.

All Freelin-Wade tubing is extruded in the USA.



Virtually everything in this catalog is available to ship within 24 hours of your order.

Warranty

Freelin-Wade warrants its products against defects of workmanship and/or material for 30 days from the date of sale. Freelin-Wade Company is not liable for consequential or other damages including, but not limited to personal injury, damage, loss, or any other expense directly or indirectly arising from the use of, or inability to use, its products either separately or in combination with other products. All other warranties expressed or implied, whether oral or written, including but not limited to warranties for fitness or merchantability for a particular purpose are expressly excluded.

other regulations, Freelin-Wade encourages user testing, especially for manufacturers of products and/or devices used in food, drug and biological applications as regulations and criteria for certification of these products and/or devices vary widely. The responsibility for determining the validity and suitability of use of a Freelin-Wade product in any product or device application is that of the user. We will gladly provide samples for user testing.

Though many of the base resins that Freelin-Wade uses comply with various FDA, NSF and

This warranty is limited to replacement of the product or an account credit in the amount of the original selling price, at the option of Freelin-Wade Company. All product presumed to be defective must be returned by prepaid transportation to Freelin-Wade Company, together with information describing the product's performance. All returns require prior authorization by Freelin-Wade Company. All specifications are subject to change without notice. While accuracy is thought reliable, no guarantee is expressed or implied.

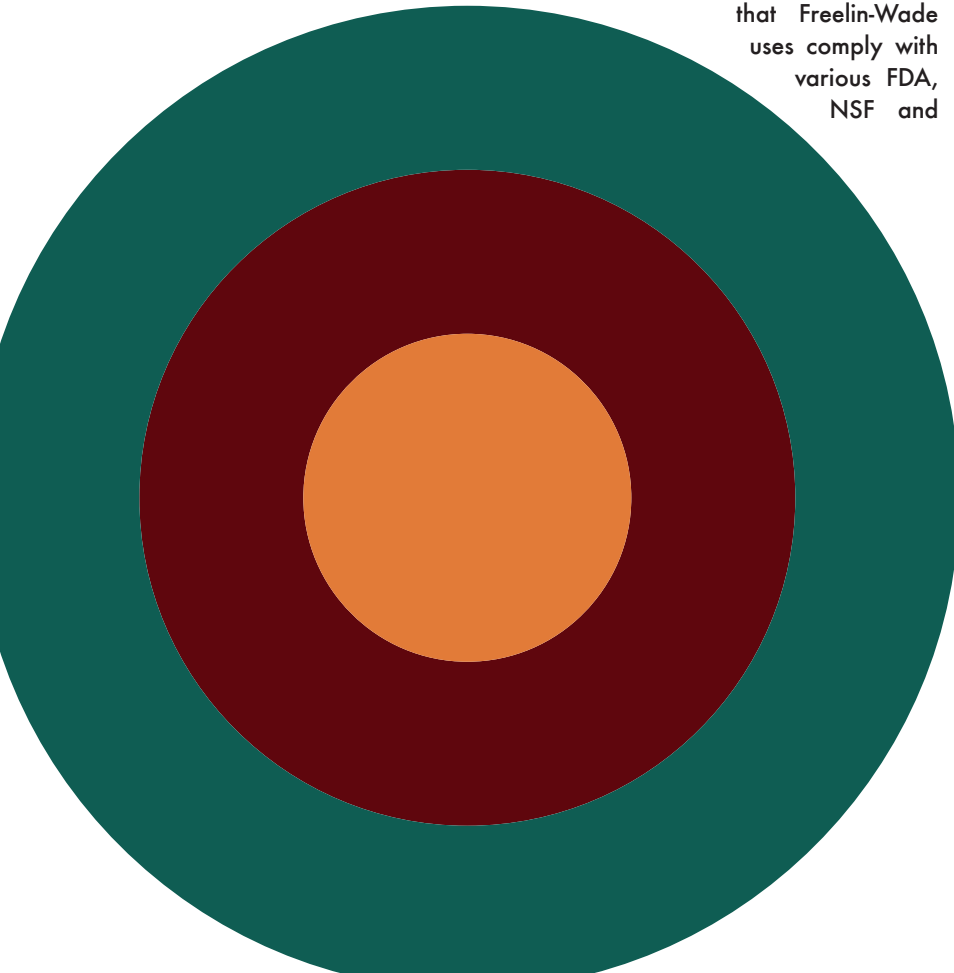

All Rights Reserved. No part of this publication may be reproduced, either through electronic, printed, or any other means without specific consent from Freelin-Wade Company.

Items in this catalog may vary in appearance from what is pictured or illustrated. Always request a manufactured product sample to assure accuracy.

Product descriptions, specifications and availability may change without notice.

Table of Contents

Variations

Variations are easy! Most of the items in this catalog can be easily altered to meet your individual needs.

Variations

4

Polyurethane: PUR

Freelin-Wade's ether-based Frethane® polyurethane is our most versatile resin. It is highly flexible, has excellent memory and is available in a rainbow of colors. Available in tubing, self-storing retractable coils, multi-tube bonded MCR and our industry leading, Flexeel® hose.

Polyurethane

8

Polyvinyl Chloride: PVC

Clear, lightweight and highly flexible, PVC is the choice for hospital and food grade applications. Available in standard tubing and in a reinforced hose.

PVC

19

Polyethylene & Liquiflex-POE™

All of our polyethylene is now linear low density. Check out our new, very flexible Liquiflex-POE. All are chemical resistant and FDA compliant for food contact.

Polyethylene

20

Nylon

Our strong, lightweight and flexible nylon is a great choice when you need tubing or retractable coils that resist heat, light and corrosion.

Nylon

22

Specialty Tubing

Freelin-Wade manufactures a variety of tubing options including Kynar®, FEP, Static Dissipative and Spatter Guard SRT.

Specialty

28

Hoses

In addition to our famous Flexeel® brand hose, Freelin-Wade offers a variety of hoses including Reinforced PUR, Flexi-Corr™ & Asepsi-Flex®.

Hoses

34

Jacketing & Accessories

Everything you need to cut, clip and channel your tubing.

Accessories

36

Chemical Resistance Guide & Index

Guidelines regarding chemical interactions with our major tubing types.
Part number index.

Guide

38

Variations

Freelin-Wade sets the industry standard for fast turnaround.

This catalog describes our wide selection of standard tubing, hose and accessories. We also manufacture what we call “variations.” Most variations involve taking our in-stock tubing and personalizing it to our customer’s specifications. This includes coiling, bonding, cutting, special packaging or printing. Let us engineer a custom size, shape or color for your specific application.

Assembly

Most of our tubing comes without fittings. If you would like your tubing to come with fittings, let us know. We have the equipment and personnel to make assembly a fast and efficient process.

Bonding

Freelin-Wade has developed a special bonding process that can combine two or more tubes of any size and color. Just pick your tubing and have us bond them. It will make your work area more organized and simplify the task of line tracing. Bonding also makes your lines look more professional and user-friendly.

Coextrusion

With our coextrusion capabilities, you are no longer limited to the properties of one tube. For example, you can have the flexibility of Polyurethane and the chemical resistance of Nylon.

Coiling

A coil is an excellent way to keep tubing organized and out of the way. We offer several standard coils in this catalog but it’s easy for us to make a variation. Refer to page 33 for a list of coiling terminology.

Colors

In addition to our 28 stock colors, it’s easy for us to match virtually any color you can dream up. Just send us a swatch of what you want us to match. It’s simple, and we’re the fastest in the industry at turning color variations around.

Cutting

We have the right equipment and are set up to precisely cut our tubing in an efficient and cost-effective manner. If you need your tubing cut into specific lengths, then save time, money and reduce waste by having us cut the tubing for you.

Forming

An excellent alternative to the high cost of injection molded parts. Formed shapes can eliminate problems such as kinking and space constraints and often makes installation easier.

Jacketing

If you want to route wire with your tubing or bundle a variety of tubes and wires together, ask us how we can help. For short lengths, we can pull the tubing and wire through the jacket material. For longer lengths we can extrude a jacket over the top.

Packaging and Labeling

Our standard packaging process is to put short lengths in bags while longer lengths come on reels or in boxes. Other packaging options, custom reels, header cards and labels are available. Just ask!

Printing

Freelin-Wade can print your custom specs on any order over 5,000 feet for free, or a nominal charge for smaller orders. The print is usually text but we also have graphics capabilities.

Sizes

Don’t see the tube dimensions that you need? We have most dies already made, as well as an in-house die shop. We’re happy to extrude exactly the tube that you need.

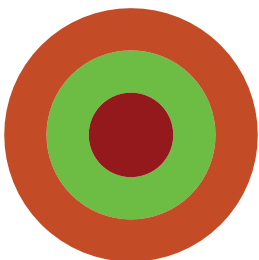
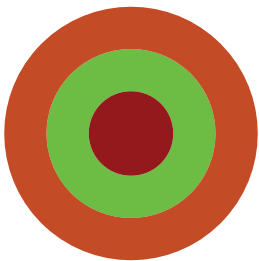
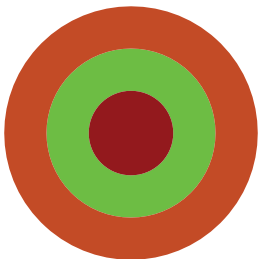

Variation Lead Times

The majority of our catalog items are available for shipment within 24 hours of your order. Our general lead times for variations using stock tubing are:

- Coil variations - next day
- Cut lengths - 3 days
- Custom printing - 3 days
- Bonding variations - 2 weeks
- Custom extrusions - 3 weeks
- Forming - 2 weeks



Assembly

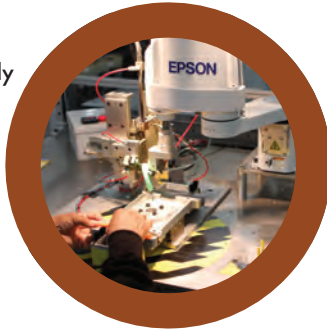

Packaging



Printing

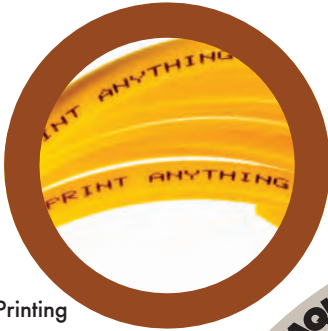

Bonding



Size



Cut Lengths

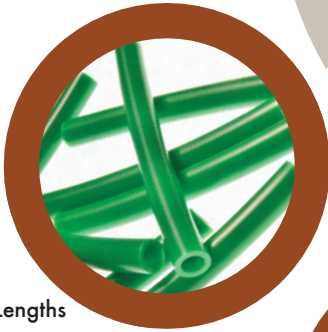

Forming



Colors



Coiling



Off-Catalog Plastics

In addition to our standard stock, on a daily basis we work with 13 other resin formulas. If you are looking for something a bit different than our standard tubing resin, call us. We can provide you with a solution to meet your needs. Below is our list of non-catalog polymers, along with some of the properties of each:

Nylon 11 - Semi-Rigid FDA: FDA 21 CFR 177.1500(5.2). This is a Nylon 11 for contact with food.

PEBAX: This is a special nylon/polyurethane hybrid material.

PUR 58D - F/R: This is a fire-retardant grade of Polyurethane in 58D durometer.

PUR 80A: This material is stiffer than our 70A but more flexible than our 85A.

PUR 80A - NSF: This material is similar to the 80A but the resin complies with NSF 61 (potable water systems).

PUR 80A - Medical: This is a medical grade polyurethane.

PUR 85A - F/R: This is a fire-retardant grade of Polyurethane in 85A durometer.

PUR 85A - Ester: Our standard polyurethanes are Ether-based polymers. The Ester is slightly better at handling oil but degrades quickly if exposed to water.

PVC 70A, 85A: These are non-phthalate PVC materials.

PVC 85A Matte: This is a non-glossy PVC material.

TPE 80A: A thermoplastic alternative to rubber.

Silcryn: Similar in feel and appearance to silicone, this specialty plastic is a great choice for medical equipment.

Standard Packaging Options

A Standard Bulk Cardboard Reel

21" diameter x 6" wide with 1" I.D. center hub.

AA Double Wide Bulk Cardboard Reel

Same size as "A" reel except 12" wide with an open hub.

B Medium Plastic Reel

10.5" diameter x 6" wide with 3/4" I.D. center hub.

C Small Plastic Reel

6.5" diameter x 6" wide with 3/4" I.D. center hub.

D, L Dispenser Boxes

E Cut Lengths

J Plastic Bag

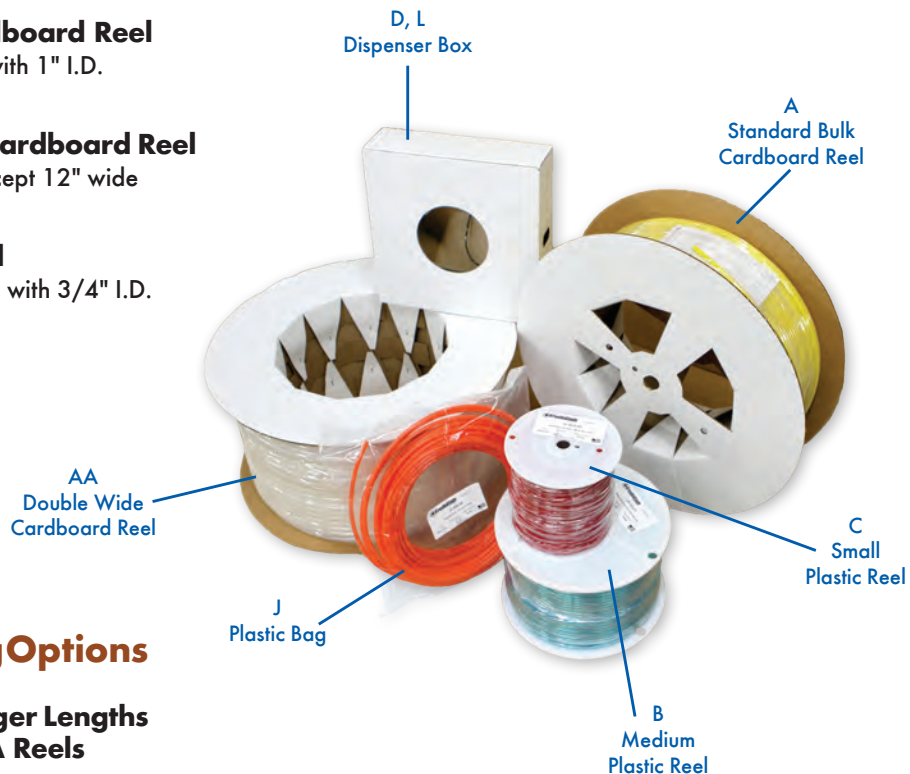

Custom Packaging Options

- Lazy Susan Bundles
- Plastic Reels for Longer Lengths
- Corrugated Plastic A Reels

Formed Tubing Variations

An excellent alternative to the high cost of creating an injection molded part. Freelin-Wade can rapidly develop formed tubing and hose parts for your prototype or production needs. Formed shapes can eliminate problems such as kinking and space constraints and often makes installation easier.

Some common requests we receive include:

- **Elbows**
- **Curves**
- **Multiple Bends**

Reasons to use a formed tube

- Reduced chance of machine down time due to kinking or improper assembly.
- Allows tube to be shaped very closely to be placed tightly within machine design requirements.
- Reduced assembly time, no measuring and cutting or associated potential errors.
- Uniform, professional appearance with a higher perceived value.
- Allows easy maintenance with factory formed parts, identifiable by part number.
- Allows very tight placement of components in an assembly with predictable results.
- Offered in 2-D configurations.

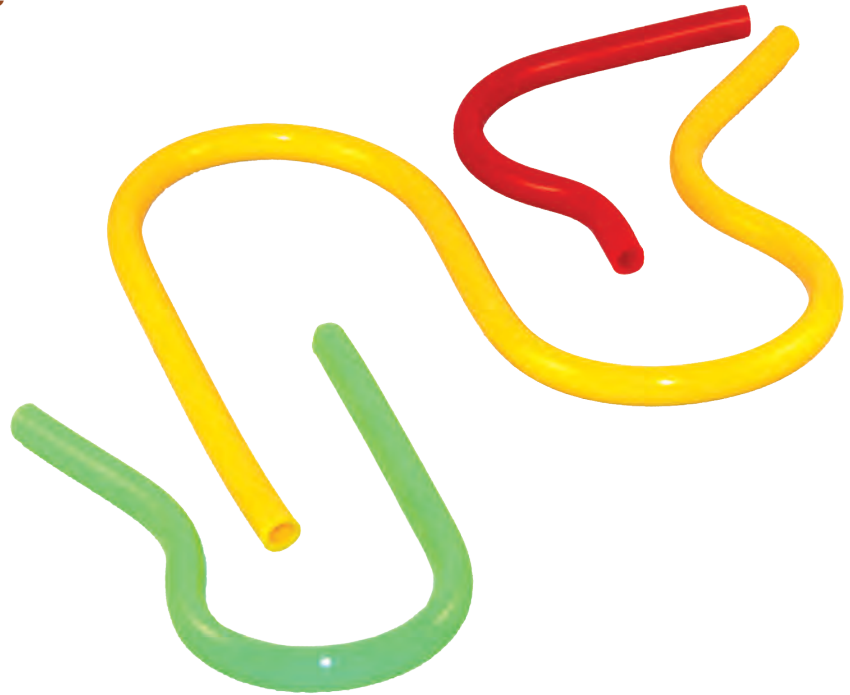

Not Just our Green Tubing is Green

At Freelin-Wade, reducing, recycling and reusing are ingrained into our culture.

Office: Employees recycle virtually all paper and other office waste. In addition, we continue to make strides toward going "paperless".

Manufacturing: We recycle our scrap in-house and throughout our operation. This dramatically cuts our waste and reduces our footprint on the environment.

Freelin-Wade utilizes mechanical and electronic filtering systems to remove oil particulates from smoke generated during production operations before exhausting to the atmosphere.

Water Usage: Freelin-Wade uses chilled filtered water to cool its extruded products. This water is recycled during the production process and then drained. Independent tests ensure that no contaminants are released.

Chemicals: Freelin-Wade recycles/destroys its machine oils & hazardous waste chemicals through licensed companies in accordance with EPA guidelines.

Die Cleaning: Freelin-Wade utilizes a high temperature, zero emission burn-off oven to remove plastic film left on tooling. This system eliminates any particulates entering the atmosphere.

Contaminated Plastic Materials: Freelin-Wade recycles waste plastic with licensed plastic recycling companies.



Fre-Thane® Polyurethane

Specifications

Temperature Range
-40° F to +165° F

Vacuum Rating
85A-95A: To 28" Hg.
70: To 20" Hg.

Diameter Tolerances
1/8" - 9/16": ±.005"
3/4": ±.007"
Metric: ±.127 mm

Tube Markings
None

Working Pressure
3:1 Safety Factor

UV Stabilized
95A & 85A

Resin Compliance
95A: NSF61
Meets UL94HB
90A: NSF61, FDA,
USPVI
85A: NSF61
Meets UL94HB
USPVI
70A: Meets UL94HB
FDA

Suggested Fittings
95A: Barb, Push-In, FX
90A: Barb
85A: Barb
70A: Barb



Polyurethane was invented in 1937 by German chemist Friedrich Bayer. His first fibers, named Perlon U, gained popularity during World War II as a replacement for rubber. Its first commercial application was as a thread to make a lightweight, stretchable fabric, called spandex.* Polyurethane is comprised of two basic materials, isocyanate and polyol.

There are two general classes of polyurethane and both are commonly found in the market: Ether-base and Ester-base. Chemically, these are made from two different polyol alcohols that cause similar, but different reactions in the isocyanate. From the user's standpoint, the Ester-base polymer is less expensive. However, it degrades when exposed to moisture. Because of this, we manufacture our Fre-Thane® polyurethane tubing using the Ether-base material.

Freelin-Wade's Fre-Thane® has a high resistance to abrasion while being highly flexible and kink resistant. Its most notable quality though is its "memory." Fre-Thane® will stretch and flex but always return to its original shape.

Freelin-Wade began manufacturing polyurethane tubing in 1980. It remains our flagship product today. It is available in 23 standard colors and a virtually infinite number of color variations. Fre-Thane® is Freelin-Wade's most versatile product, with more options and variations available than with any other tubing.

* Source: www.madehow.com

Fre-Thane Polyurethane Colors

Any of our polyurethane tubing products listed on pages 9 and 10 are available in the colors shown below. If not shown as a standard item, please allow 4 weeks to fulfill your order.



Fre-Thane® 95A Polyurethane

Part Number & Color Code	Packaging Unit Size	OD	ID	Wall	Standard Colors	Working Pressure		lbs./100'	Bend Radius	Fitting
						75°F/25°C	150°F/65°C			
1J-157- ___ 50' Bag										
1L-157- ___ 250' Box										
1C-157- ___ 500' Reel		1/8"	.066"	.030"	01 04 05 06 07 08 10 11 12 14 25 26 27 28 29	255 PSI	100 PSI	.44	1/4"	B, PI
1B-157- ___ 1000' Reel										
1A-157- ___ 2500' Reel										
1J-156- ___ 100' Bag										
1C-156- ___ 500' Reel		5/32"	3/32"	.031"	01 02 04 05 06 07 08 09 10 11 12 25 26 27 28 29 37	210 PSI	85 PSI	.62	3/8"	B, PI
1B-156- ___ 1000' Reel										
1A-156- ___ 2500' Reel										
1J-107- ___ 100' Bag										
1B-107- ___ 1000' Reel		3/16"	.107"	.040"	07 08 10	220 PSI	90 PSI	.92	3/8"	B, PI
1A-107- ___ 2000' Reel										
1J-169- ___ 100' Bag										
1B-169- ___ 500' Reel		1/4"	1/8"	.062"	01 04 05 06 07 08 09 10 11 25 26 27 28 29	265 PSI	105 PSI	1.83	1/2"	B, PI
1A-169- ___ 1000' Reel										
1J-151- ___ 100' Bag										
1B-151- ___ 500' Reel		1/4"	.160"	.045"	01 04 05 06 07 08 09 10 11 12 25 26 27 28 46	175 PSI	70 PSI	1.44	1/2"	B, PI, FX
1A-151- ___ 1000' Reel										
1J-152- ___ 100' Bag										
1B-152- ___ 250' Reel		3/8"	.245"	.065"	01 04 05 06 07 08 10 11 25 26 27 28 37 46	170 PSI	70 PSI	3.15	7/8"	B, PI, FX
1A-152- ___ 500' Reel										
1J-161- ___ 50' Bag		15/32"	5/16"	.079"	01 05 07 08 10 11 27	155 PSI	60 PSI	4.83	1-1/8"	B, PI
1A-161- ___ 250' Reel										
1J-166- ___ 50' Bag		1/2"	.320"	.090"	01 05 06 07 08 10 11 25 27	175 PSI	70 PSI	5.77	1-1/8"	B, PI
1A-166- ___ 250' Reel										
1J-163- ___ 50' Bag		9/16"	3/8"	.094"	01 07 08 10 27	155 PSI	60 PSI	6.85	1-3/8"	B, FX
1A-163- ___ 200' Reel										
1A-176- ___ 150' Reel		3/4"	.467"	.142"	01 10	175 PSI	70 PSI	13.47	1-1/2"	B, FX
1E-176- ___ Cut Length										

Our Ether-based Fre-Thane® is our most versatile tubing. Highly flexible with excellent memory, it has the most variation possibilities of any of our tubing and is available in a rainbow of colors.

Metric Sizes

Part Number & Color Code	Packaging Unit Size	OD mm	ID mm	Wall mm	Standard Colors	Working Pressure		lbs./100'	Bend Radius	Fitting
						75°F/25°C	150°F/65°C			
1J-171- ___ 100' Bag										
1C-171- ___ 500' Reel		3	1.8	.6	01 10	230 PSI	90 PSI	.35	6.4 mm	B, PI
1B-171- ___ 1000' Reel										
1A-171- ___ 2500' Reel										
1J-156- ___ 100' Bag										
1C-156- ___ 500' Reel		4	2.4	.8	01 02 04 05 06 07 08 09 10 11 12 25 26 27 28 29 37	210 PSI	85 PSI	.62	9.5 mm	B, PI
1B-156- ___ 1000' Reel										
1A-156- ___ 2500' Reel										
1J-158- ___ 100' Bag										
1B-158- ___ 500' Reel		6	4	1	01 04 05 06 07 08 09 10 11 25 26 27 28 37	160 PSI	65 PSI	1.21	12.7 mm	B, PI
1A-158- ___ 1000' Reel										
1J-159- ___ 100' Bag										
1A-159- ___ 500' Reel		8	5	1.5	01 05 06 07 08 10 11 25 27 37	190 PSI	75 PSI	2.36	19 mm	B, PI
1J-160- ___ 50' Bag										
1A-160- ___ 500' Reel		10	6.5	1.75	01 05 06 07 08 10 27	170 PSI	70 PSI	3.51	22.2 mm	B, PI
1J-161- ___ 50' Bag										
1A-161- ___ 250' Reel		12	8	2	01 05 07 08 10 27	155 PSI	60 PSI	4.83	28.6 mm	B, PI
1J-162- ___ 50' Bag										
1A-162- ___ 200' Reel		16	11	2.5	01	150 PSI	60 PSI	4.85	76.2 mm	B, PI

Variations Available:

Coiling • Colors • Cutting • Bonding • Printing • Packaging • Sizes

US Toll Free: 888-373-9233

9

Fre-Thane® 90A Polyurethane

Part Number & Color Code	Packaging Unit Size	OD	ID	Wall	Standard Colors	Working Pressure		lbs./100'	Bend Radius	Fitting
						75°F/25°C	150°F/65°C			
1J-132- ___ 100' Bag	100' Bag									
1B-132- ___ 500' Reel	500' Reel	1/4"	.159"	.046"	01 07 08 10 14 25 27	135 PSI	55 PSI	1.43	5/8"	B
1A-132- ___ 1000' Reel	1000' Reel									
1J-045- ___ 100' Bag	100' Bag									
1B-045- ___ 500' Reel	500' Reel	1/4"	.170"	.040"	01 05 10	115 PSI	45 PSI	1.29	3/4"	
1A-045- ___ 1000' Reel	1000' Reel									
1J-153- ___ 100' Bag	100' Bag	1/4"	3/16"	.031"	10	90 PSI	35 PSI	1.06	1-1/8"	
1A-153- ___ 1000' Reel	1000' Reel									
1J-005- ___ 100' Bag	100' Bag									
1B-005- ___ 250' Reel	250' Reel	3/8"	.245"	.065"	01 05 07 10 11 25 27	125 PSI	50 PSI	3.1	3/4"	B
1A-005- ___ 500' Reel	500' Reel									
1J-111- ___ 50' Bag	50' Bag	1/2"	3/8"	.062"	01 05 10	90 PSI	35 PSI	4.2	2"	
1A-111- ___ 250' Reel	250' Reel									

Variations Available: Coiling • Colors • Cutting • Bonding • Printing • Packaging • Sizes

Fre-Thane® 85A Polyurethane

Part Number & Color Code	Packaging Unit Size	OD	ID	Wall	Standard Colors	Working Pressure		lbs./100'	Bend Radius	Fitting
						75°F/25°C	150°F/65°C			
1J-013- ___ 50' Bag	50' Bag									
1L-013- ___ 250' Box	250' Box									
1C-013- ___ 500' Reel	500' Reel	1/8"	.066"	.030"	01 02 04 05 06 07 08 09 10 11 12 14 25 26 27 28 29 32 45 46	135 PSI	55 PSI	.43	3/16"	B
1B-013- ___ 1000' Reel	1000' Reel									
1A-013- ___ 2500' Reel	2500' Reel									
1J-134- ___ 100' Bag	100' Bag									
1C-134- ___ 500' Reel	500' Reel	5/32"	3/32"	.031"	01 10	115 PSI	45 PSI	.60	3/8"	B
1A-134- ___ 2500' Reel	2500' Reel									
1J-030- ___ 100' Bag	100' Bag									
1C-030- ___ 500' Reel	500' Reel	5/32"	5/64"	.039"	01 05 06 07 08 09 10 11 12 27	155 PSI	60 PSI	.70	3/8"	B
1B-030- ___ 1000' Reel	1000' Reel									
1A-030- ___ 2500' Reel	2500' Reel									
1J-194- ___ 100' Bag	100' Bag									
1B-194- ___ 500' Reel	500' Reel	3/16"	1/8"	.031"	01 10	85 PSI	35 PSI	.74	1/2"	
1A-194- ___ 2000' Reel	2000' Reel									
1J-025- ___ 50' Bag	50' Bag									
1D-025- ___ 100' Box	100' Box	1/4"	1/8"	.062"	01 02 04 05 06 07 08 09 10 11 12 25 26 27 28 29 32 46	145 PSI	60 PSI	1.8	1/2"	B
1B-025- ___ 500' Reel	500' Reel									
1A-025- ___ 1000' Reel	1000' Reel									
1J-149- ___ 100' Bag	100' Bag	5/16"	3/16"	.062"	01 07 10 27	110 PSI	45 PSI	2.4	5/8"	
1A-149- ___ 500' Reel	500' Reel									
1J-015- ___ 100' Bag	100' Bag	3/8"	1/4"	.062"	01 10 25 26 27	90 PSI	35 PSI	3.0	3/4"	B
1A-015- ___ 500' Reel	500' Reel									

Variations Available: Coiling • Colors • Cutting • Bonding • Printing • Packaging • Sizes

Fre-Thane® 70A Polyurethane

Part Number & Color Code	Packaging Unit Size	OD	ID	Wall	Standard Colors	Working Pressure		lbs./100'	Bend Radius	Fitting
						75°F/25°C	150°F/65°C			
1J-133- ___ 100' Bag	100' Bag									
1B-133- ___ 500' Reel	500' Reel	1/4"	1/8"	.062"	01 10 14 25 26 27 29	60 PSI	30 PSI	1.69	1/2"	B
1A-133- ___ 1000' Reel	1000' Reel									
1J-170- ___ 100' Bag	100' Bag	3/8"	1/4"	.062"	07 10	50 PSI	25 PSI	2.82	3/4"	B
1A-170- ___ 500' Reel	500' Reel									

Variations Available: Coiling • Colors • Cutting • Bonding • Printing • Packaging • Sizes

Multi-Bore Polyurethane

Specifications

Temperature Range
-40°F to +165°F

Vacuum Rating
To 28" Hg.

Diameter Tolerances
±.005"

Tube Markings
None

Working Pressure
3:1 Safety Factor

UV Stabilized
85A

Resin Compliance
See Fre-Thane®
compliances on page 8

Suggested Fittings
Barb

Standard Tail Lengths
8" and 16"

Multi-Bore tubing is produced using our Fre-Thane® polyurethane in a single extrusion. Unlike MCR, it is made in one extrusion, which means the tube can only be made in a single color. Unlike MCR, Multi-Bore can't be separated cleanly and should not be used with push-in fittings.

If you require more colors than are listed here, consider using our Multi-Colored Ribbon (MCR). See page 20 for more information about MCR.

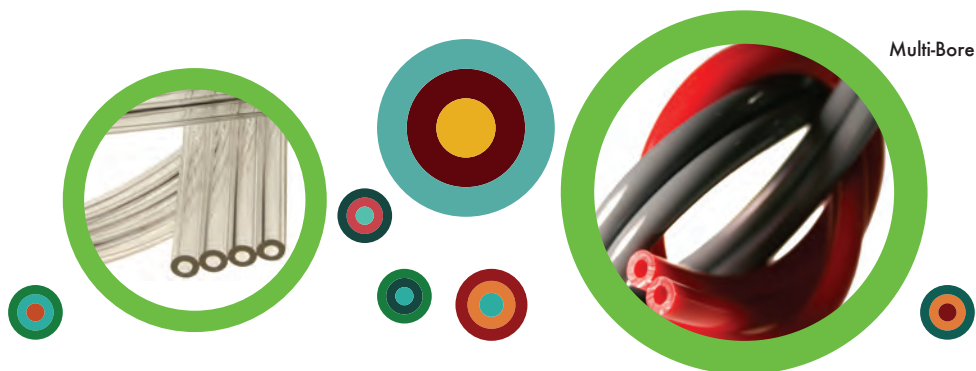

85A Multi-Bore Polyurethane

Part Number & Color Code	Packaging Unit Size	OD	ID	Configuration	Standard Colors	Working Pressure		lbs./100'	Fitting
						75°F/25°C	150°F/65°C		
3J-028- ___	100' Bag	1/8"	.066"	Triple Tube	10	125 PSI	50 PSI	1.7	B
3A-028- ___	1000' Reel								
4J-026- ___	100' Bag	1/8"	.066"	Quad Tube	10	125 PSI	50 PSI	2.2	B
4A-026- ___	500' Reel								
2J-016- ___	100' Bag	1/4"	1/8"	Twin Tube	01 05 10 27	150 PSI	60 PSI	4.1	B
2A-016- ___	500' Reel								
4J-023- ___	50' Bag	1/4"	1/8"	Quad Tube	10	150 PSI	60 PSI	8.4	B
4A-023- ___	250' Reel								

90A Multi-Bore Polyurethane

Part Number & Color Code	Packaging Unit Size	OD	ID	Configuration	Standard Colors	Working Pressure		lbs./100'	Fitting
						75°F/25°C	150°F/65°C		
2J-006- ___	100' Bag	1/8"	1/16"	Twin Tube	01 10 14	190 PSI	75 PSI	1.1	B
2B-006- ___	1000' Reel								
2A-006- ___	2000' Reel								
2J-013- ___	100' Bag	1/4"	.159"	Twin Tube	14	130 PSI	50 PSI	2.9	B
2A-013- ___	500' Reel								
2J-024- ___	100' Bag	3/8"	1/4"	Twin Tube	01 10	120 PSI	50 PSI	6.8	B
2A-024- ___	250' Reel								

Variations Available: Coiling • Cutting • Bonding • Printing • Packaging • Sizes

Multi-Bore Coils

Part Number & Color Code	OD	ID	Bore/DUR	Standard Colors	Working Pressure		Material Length	Working Length	Retracted Length	Coil ID
					75°F/25°C	150°F/65°C				
2V-006- ___	1/8"	1/16"	Twin 90A	01 10 14	160 PSI	65 PSI	7'	5'	6"	3/4"
2W-016- ___	1/4"	1/8"	Twin 85A	01 05 10 27	130 PSI	50 PSI	10'	8'	12.5"	1"
4W-023- ___	1/4"	1/8"	Quad 85A	10	130 PSI	50 PSI	10'	7'	21"	1-1/4"

Variations Available: Cutting • Printing • Packaging

Multi-Colored Ribbon (MCR)

Specifications

Temperature Range
-40°F to +165°F

Vacuum Rating
85A-95A: To 28" Hg.

Diameter Tolerances
1/8" - 9/16": ±.005"
3/4": ±.007"
Metric: ±.127mm

Tube Markings
None

Working Pressure
3:1 Safety Factor

UV Stabilized
95A & 85A

Resin Compliance
95A: NSF61
Meets UL94HB
85A: NSF61
Meets UL94HB
USPVI

Suggested Fittings
95A: Barb, Push-In, FX
85A: Barb

Multi-Colored Ribbon tubing (MCR) is a bonded ribbon of multi-colored Fre-Thane® Polyurethane tubing. Any time that you are routing two or more lines, MCR is the way to go. It offers faster installation times and eliminates the need for spiral wrap or jacketing.

Freelin-Wade's proprietary bonding process allows the tubing to be separated without leaving any residue. This ensures a tight, leak free seal with push-in style fittings. MCR is a durable, cost-effective way to color code your tubing lines for identification, tracing or troubleshooting. Additionally, MCR will withstand the rigors of flexing and stretching, just like the rest of our polyurethane tubing.

MCR is available in a wide range of stock configurations which are listed below and to the right. In addition, variations are easy. Freelin-Wade will make MCR to suit your needs. Our unique manufacturing process enables us to bond up to 20 tubes, mixing and matching colors, sizes and configurations.

Features

- Bond 2 to 20 tubes, up to 3.5" wide
- Use multiple colors in any combination.
- Mix or match tube sizes.
- Tubes can be stacked into many configurations.
- Color code your lines making routing and line identification easy.

Common MCR Variations



85A Standard Multi-Colored Ribbon (MCR)

Part Number & Color Code	Packaging Unit Size	OD	ID	Color Arrangement	Working Pressure 75°F/25°C	lbs./ 100'	Bend Radius	Fitting
2M-013-01-10 2ME-013-01-10	100' Bag Cut Length	1/8"	.066"	01 10	135 PSI	.86	3/16"	B
4M-013-26-28-29-25 4ME-013-26-28-29-25	100' Bag Cut Length	1/8"	.066"	26 28 29 25	135 PSI	1.72	3/16"	B
6M-013-06-07-05-08-09-12 6ME-013-06-07-05-08-09-12	100' Bag Cut Length	1/8"	.066"	06 07 05 08 09 12	135 PSI	2.58	3/16"	B
8M-013-11-04-32-27-26-28-29-25 8ME-013-11-04-32-27-26-28-29-25	100' Bag Cut Length	1/8"	.066"	11 04 32 27 26 28 29 25	135 PSI	3.44	3/16"	B
2M-025-01-10 2ME-025-01-10	100' Bag Cut Length	1/4"	1/8"	01 10	145 PSI	3.60	1/2"	B
4M-025-26-28-29-25 4ME-025-26-28-29-25	100' Bag Cut Length			26 28 29 25				
6M-025-06-07-05-08-09-12 6ME-025-06-07-05-08-09-12	100' Bag Cut Length	1/4"	1/8"	06 07 05 08 09 12	145 PSI	10.80	1/2"	B
8M-025-11-04-32-27-26-28-29-25 8ME-025-11-04-32-27-26-28-29-25	100' Bag Cut Length	1/4"	1/8"	11 04 32 27 26 28 29 25	145 PSI	14.40	1/2"	B

Variations Available:

Coiling • Colors • Cutting • Packaging • Sizes

95A Standard Multi-Colored Ribbon (MCR)

Part Number & Color Code	Packaging Unit Size	OD	ID	Color Arrangement	Working Pressure 75°F/25°C	lbs./100'	Bend Radius	Fitting
2M-157-05-07 2ME-157-05-07	100' Bag Cut Length	1/8"	.066"	05 07	255 PSI	.88	1/4"	B, PI
4M-157-05-07-11-10 4ME-157-05-07-11-10	100' Bag Cut Length	1/8"	.066"	05 07 11 10	255 PSI	1.72	1/4"	B, PI
6M-157-08-06-05-07-11-10 6ME-157-08-06-05-07-11-10	100' Bag Cut Length	1/8"	.066"	08 06 05 07 11 10	255 PSI	2.60	1/4"	B, PI
8M-157-25-27-08-06-05-07-11-10 8ME-157-25-27-08-06-05-07-11-10	100' Bag Cut Length	1/8"	.066"	25 27 08 06 05 07 11 10	255 PSI	3.52	1/4"	B, PI
2M-156-05-07 2ME-156-05-07	100' Bag Cut Length	5/32"	3/32"	05 07	210 PSI	1.24	3/8"	B, PI
4M-156-05-07-11-10 4ME-156-05-07-11-10	100' Bag Cut Length	5/32"	3/32"	05 07 11 10	210 PSI	2.48	3/8"	B, PI
6M-156-08-06-05-07-11-10 6ME-156-08-06-05-07-11-10	100' Bag Cut Length	5/32"	3/32"	08 06 05 07 11 10	210 PSI	3.72	3/8"	B, PI
2M-151-05-07 2ME-151-05-07	100' Bag Cut Length	1/4"	.160"	05 07	175 PSI	2.88	1/2"	B, PI, FX
4M-151-05-07-11-10 4ME-151-05-07-11-10	100' Bag Cut Length	1/4"	.160"	05 07 11 10	175 PSI	5.76	1/2"	B, PI, FX
6M-151-08-06-05-07-11-10 6ME-151-08-06-05-07-11-10	100' Bag Cut Length	1/4"	.160"	08 06 05 07 11 10	175 PSI	8.64	1/2"	B, PI, FX
8M-151-25-27-08-06-05-07-11-10 8ME-151-25-27-08-06-05-07-11-10	100' Bag Cut Length	1/4"	.160"	25 27 08 06 05 07 11 10	175 PSI	11.52	1/2"	B, PI, FX
2M-152-05-07 2ME-152-05-07	100' Bag Cut Length	3/8"	.245"	05 07	170 PSI	6.30	7/8"	B, PI, FX
4M-152-05-07-11-10 4ME-152-05-07-11-10	100' Bag Cut Length	3/8"	.245"	05 07 11 10	170 PSI	12.60	7/8"	B, PI, FX

Metric Sizes

Part Number & Color Code	Packaging Unit Size	OD	ID	Color Arrangement	Working Pressure 75°F/25°C	lbs./100'	Bend Radius	Fitting
2M-156-05-07 2ME-156-05-07	100' Bag Cut Length	4mm	2.4mm	05 07	210 PSI	1.24	9.5mm	B, PI
4M-156-05-07-11-10 4ME-156-05-07-11-10	100' Bag Cut Length	4mm	2.4mm	05 07 11 10	210 PSI	2.48	9.5mm	B, PI
6M-156-08-06-05-07-11-10 6ME-156-08-06-05-07-11-10	100' Bag Cut Length	4mm	2.4mm	08 06 05 07 11 10	210 PSI	3.72	9.5mm	B, PI
2M-158-09-01 2ME-158-09-01	100' Bag Cut Length	6mm	4mm	09 01	160 PSI	2.42	12.7mm	B, PI
4M-158-09-01-11-10 4ME-158-09-01-11-10	100' Bag Cut Length	6mm	4mm	09 01 11 10	160 PSI	4.84	12.7mm	B, PI
2M-159-06-08 2ME-159-06-08	100' Bag Cut Length	8mm	5mm	06 08	190 PSI	4.72	19mm	B, PI
4M-159-06-08-11-10 4ME-159-06-08-11-10	100' Bag Cut Length	8mm	5mm	06 08 11 10	190 PSI	9.44	19mm	B, PI

Variations Available:

Coiling • Colors • Cutting • Packaging • Sizes

95A Multi-Colored Ribbon (MCR) Coils

Part Number & Color Code	OD	ID	Tail Length	Color Arrangement	Working Pressure 75°F/25°C 150°F/65°C	Material Length	Working Length	Retracted Length	Coil ID
2MC-156-5 2MC-156-10	5/32"	3/32"	8"	05 07	190 PSI 75 PSI	5' 10'	3.75' 7.5'	3.75" 9"	1" 1"
2MC-151-5 2MC-151-10	1/4"	.160"	8"	05 07	155 PSI 60 PSI	5' 10'	3.75' 7.5'	5.6" 13.25"	1" 1"
2MC-152-5 2MC-152-10	3/8"	.245"	8"	05 07	150 PSI 60 PSI	5' 10'	3.75' 7.5'	5" 11.5"	1.75" 1.75"

Variations Available:

Colors • Cutting • Packaging • Sizes

US Toll Free: 888-373-9233

13

Flexeel® Polyurethane Reinforced Hose is an excellent alternative to much bulkier rubber hoses. Extremely lightweight and tough, it is ideal for either outdoor or indoor use. Flexeel retains its flexibility even in cold environments.

Flexeel®

Specifications

Temperature Range
-40°F to +165°F

Pressure Rating 70°F
200 P.S.I.

Vacuum Rating
To 28" Hg.

Diameter Tolerances
1/4" - 5/16" ±.005"
3/8" - 1/2" ±.010"

Working Pressure
4:1 Safety Factor

UV Stabilized Yes

Resin Compliance
NSF61, UL94HB

Suggested Fittings
Reusable with Strain Relief

Features

- Withstands constant flexing, even in subzero conditions.
- Kink & abrasion resistant.
- Much lighter than other comparably sized hoses.
- Very small bend radius.
- Resistant to chemicals, water, fuel, oil and fungus.
- Non-marring to furniture and auto finishes.

* In addition to color choice, select fittings for both ends of the coil.



Rigid Fitting with Strain Relief

Flexeel® Polyurethane Straight Hose

Part Number & Color Code	Packaging Unit Size	OD	ID	Standard Colors	Bend Radius	Fitting
PFE4025	—	—	—	—	—	None
PFE40254	25'	3/8"	1/4"	T TR TY	7/8"	Reusable Strain Relief 1/4 MPT
PFE40256	—	—	—	—	—	Reusable Strain Relief 3/8 MPT
PFE4050	—	—	—	—	—	None
PFE40504	50'	3/8"	1/4"	T TR TY	7/8"	Reusable Strain Relief 1/4 MPT
PFE40506	—	—	—	—	—	Reusable Strain Relief 3/8 MPT
PFE4100	—	—	—	—	—	None
PFE41004	100'	3/8"	1/4"	T TR TY	7/8"	Reusable Strain Relief 1/4 MPT
PFE41006	—	—	—	—	—	Reusable Strain Relief 3/8 MPT
PFE4500	500'	3/8"	1/4"	T TR TY	7/8"	None
PFE42000	2000'	3/8"	1/4"	T TR TY	7/8"	None
PFE5025	—	—	—	—	—	None
PFE50254	25'	.473"	5/16"	T TR TY	1 1/4"	Reusable Strain Relief 1/4 MPT
PFE5050	—	—	—	—	—	None
PFE50504	50'	.473"	5/16"	T TR TY	1 1/4"	Reusable Strain Relief 1/4 MPT
PFE5100	—	—	—	—	—	None
PFE51004	100'	.473"	5/16"	T TR TY	1 1/4"	Reusable Strain Relief 1/4 MPT
PFE5250	250'	.473"	5/16"	T TR TY	1 1/4"	None
PFE51500	1500'	.473"	5/16"	T TR TY	1 1/4"	None
PFE6025	—	—	—	—	—	None
PFE60254	25'	9/16"	3/8"	T TR TY	1 1/2"	Reusable Strain Relief 1/4 MPT
PFE60256	—	—	—	—	—	Reusable Strain Relief 3/8 MPT
PFE6050	—	—	—	—	—	None
PFE60504	50'	9/16"	3/8"	T TR TY	1 1/2"	Reusable Strain Relief 1/4 MPT
PFE60506	—	—	—	—	—	Reusable Strain Relief 3/8 MPT
PFE6100	—	—	—	—	—	None
PFE61004	100'	9/16"	3/8"	T TR TY	1 1/2"	Reusable Strain Relief 1/4 MPT
PFE61006	—	—	—	—	—	Reusable Strain Relief 3/8 MPT
PFE6200	200'	9/16"	3/8"	T TR TY	1 1/2"	None
PFE61000	1000'	9/16"	3/8"	T TR TY	1 1/2"	None
PFE8025	—	—	—	—	—	None
PFE80258	25'	.700"	.440"	T	1 5/8"	Reusable 1/2 MPT
PFE8050	—	—	—	—	—	None
PFE80508	50'	.700"	.440"	T	1 5/8"	Reusable 1/2 MPT
PFE8100	—	—	—	—	—	None
PFE81008	100'	.700"	.440"	T	1 5/8"	Reusable 1/2 MPT
PFE8200	200'	.700"	.440"	T	1 5/8"	None
PFE8500	500'	.700"	.440"	T	1 5/8"	None

Variations Available:

Coiling • Colors • Cutting • Bonding • Printing • Packaging

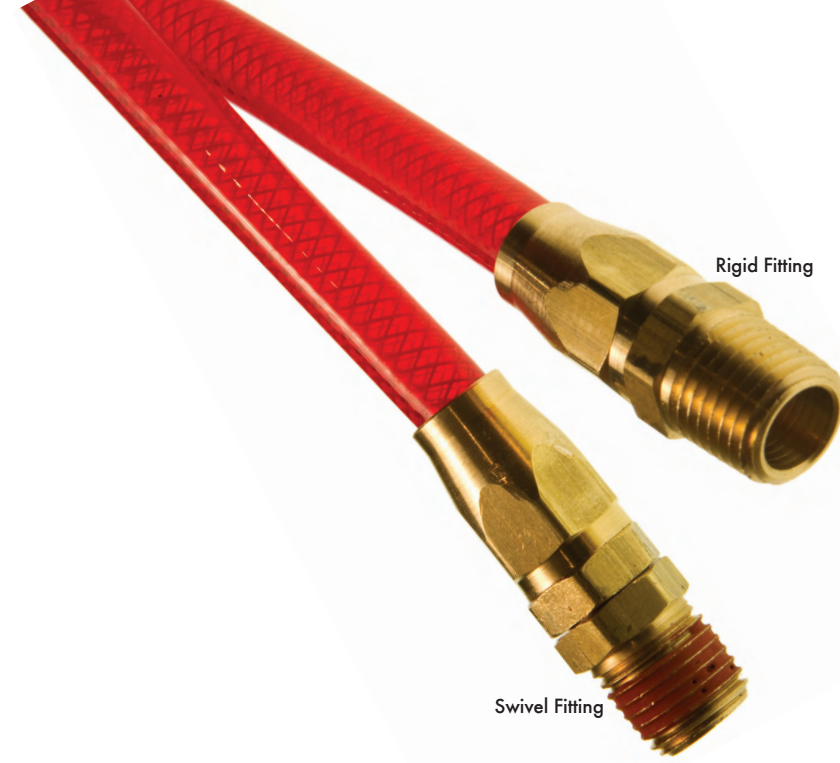

Available in:

- T Transparent Blue
- TR Transparent Red
- TY Transparent Yellow

Standard Tail Lengths
8" and 16"

Flexeel® Coiled Polyurethane Hose

Reusable Fittings – with Strain Relief										
Part Number, Fitting & Color Code	Fitting Options	Standard Colors	Material Length	Working Length	Retracted Length	OD	ID	Coil OD	Working Pressure	Weight
PUE14-10	___ = (2) 1/4" Rigid		10'	8.5'	9"					.41 lbs.
PUE14-15	___ A= (1) 1/4" Rigid & (1) 1/4" Swivel	T TR TY	15'	12.5'	14.5"	3/8"	1/4"	1 3/4"	200 PSI	.59 lbs.
PUE14-20	___ B= (2) 1/4" Swivel		20'	17'	19.5"					.74 lbs.
PUE14-25	___ 6= (2) 3/8" Rigid		25'	21'	26.5"					.88 lbs.
PUE38-10	___ 4= (2) 1/4" Rigid		10'	8.5'	10.5"					1.00 lbs.
PUE38-15	___ = (2) 3/8" Rigid		15'	12.5'	16.7"					1.40 lbs.
PUE38-20	___ A= (1) 3/8" Rigid & (1) 3/8" Swivel	T TR TY	20'	17'	23"	9/16"	3/8"	2 7/8"	200 PSI	1.85 lbs.
PUE38-25	___ B= (2) 3/8" Swivel		25'	21'	29"					2.25 lbs.
Reusable Fittings – No Strain Relief										
Part Number, Fitting & Color Code	Fitting Options	Standard Colors	Material Length	Working Length	Retracted Length	OD	ID	Coil OD	Working Pressure	Weight
PRE14-10	___ = (2) 1/4" Rigid		10'	8.5'	9"					.41 lbs.
PRE14-15	___ A= (1) 1/4" Rigid & (1) 1/4" Swivel	T TR TY	15'	12.5'	14.5"	3/8"	1/4"	1 3/4"	200 PSI	.59 lbs.
PRE14-20	___ (1) 1/4" Swivel		20'	17'	19.5"					.74 lbs.
PRE14-25	___ B= (2) 1/4" Swivel		25'	21'	26.5"					.88 lbs.
PRE38-10	___ 4= (2) 1/4" Rigid		10'	8.5'	10.5"					1.00 lbs.
PRE38-15	___ 4A= (1) 1/4" Rigid & (1) 1/4" Swivel		15'	12.5'	16.7"					1.40 lbs.
PRE38-20	___ 4B= (2) 1/4" Swivel	T TR TY	20'	17'	23"	9/16"	3/8"	2 7/8"	200 PSI	1.85 lbs.
PRE38-25	___ = (2) 3/8" Rigid		25'	21'	29"					2.25 lbs.
	___ A= (1) 3/8" Rigid & (1) 3/8" Swivel									

Variations Available:

Colors • Cutting • Bonding • Printing • Packaging • Sizes

* In addition to color choice, select fittings for both ends of the coil.

US Toll Free: 888-373-9233

15

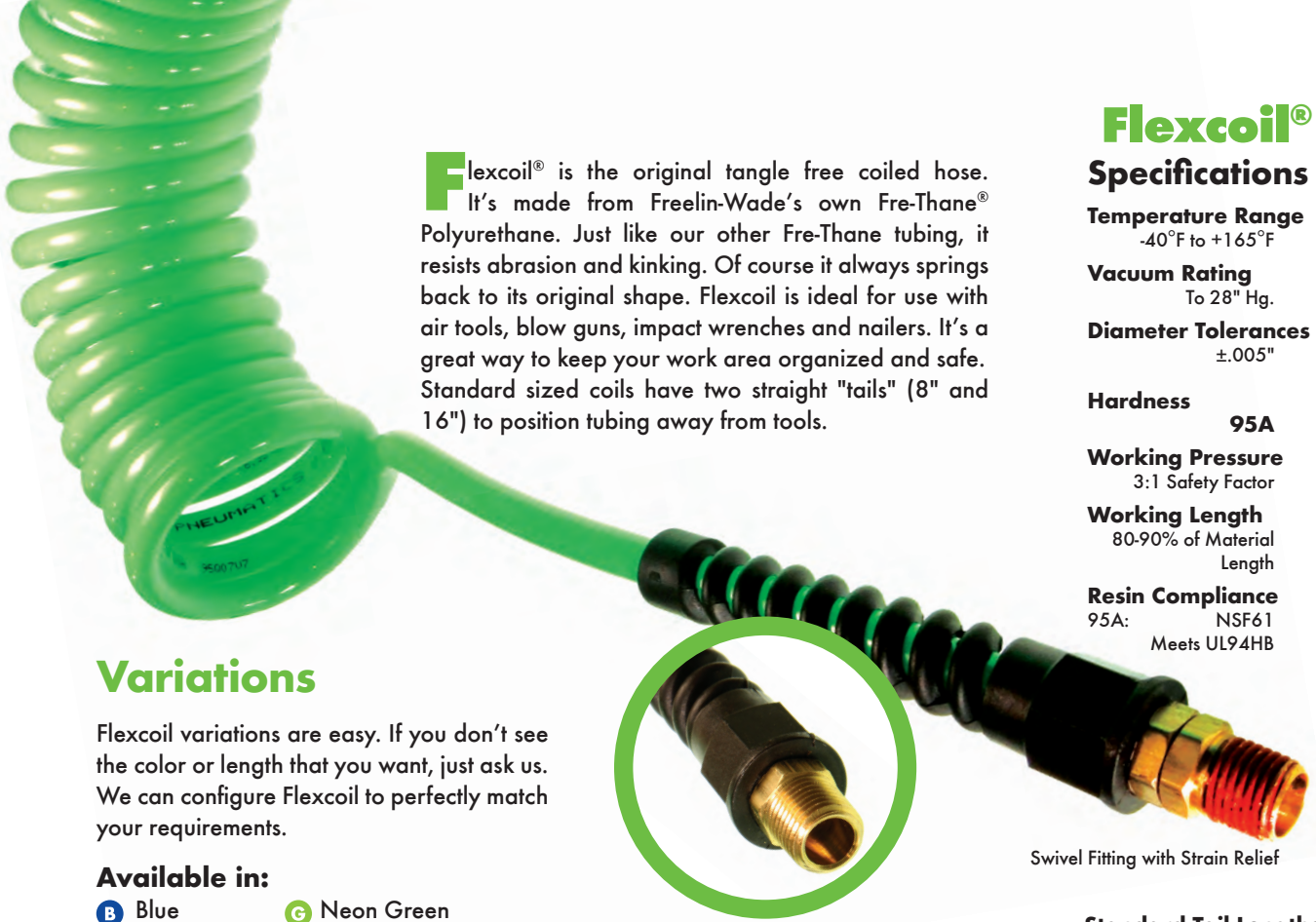

Flexcoil® is the original tangle free coiled hose. It's made from Freelin-Wade's own Fre-Thane® Polyurethane. Just like our other Fre-Thane tubing, it resists abrasion and kinking. Of course it always springs back to its original shape. Flexcoil is ideal for use with air tools, blow guns, impact wrenches and nailers. It's a great way to keep your work area organized and safe. Standard sized coils have two straight "tails" (8" and 16") to position tubing away from tools.

Flexcoil® Specifications

Temperature Range
-40°F to +165°F

Vacuum Rating
To 28" Hg.

Diameter Tolerances
±.005"

Hardness
95A

Working Pressure
3:1 Safety Factor

Working Length
80-90% of Material Length

Resin Compliance
95A: NSF61
Meets UL94HB

Variations

Flexcoil variations are easy. If you don't see the color or length that you want, just ask us. We can configure Flexcoil to perfectly match your requirements.

Available in:

- B Blue
- G Neon Green
- R Red
- Y Yellow
- T Transparent Blue



Rigid Fitting with Strain Relief

Swivel Fitting with Strain Relief

Standard Tail Lengths
8" and 16"

Flexcoil® Coiled Polyurethane with Reusable Strain Relief Fittings

Part Number, Fitting & Color Code	Fitting Options	Standard Colors	Material Length	Working Length	Retracted Length	OD	ID	Coil OD	Working Pressure	Weight
PU316-5	— = (2) 1/4" Rigid		5'	4'	2"					.23 lbs.
PU316-10	— = (2) 1/4" Rigid		10'	8'	6"					.34 lbs.
PU316-15	A= (1) 1/4" Rigid & (1) 1/4" Swivel	B G R Y T	15'	12.5'	10 1/4"	5/16"	3/16"	1 7/8"	160 PSI	.46 lbs.
PU316-20	B= (2) 1/4" Swivel		20'	17'	14 1/2"					.56 lbs.
PU316-25	B= (2) 1/4" Swivel		25'	20'	18 1/2"					.68 lbs.
PU14-5	— = (2) 1/4" Rigid		5'	4'	2 1/2"					.23 lbs.
PU14-10	— = (2) 1/4" Rigid		10'	8'	6"					.41 lbs.
PU14-15	A= (1) 1/4" Rigid		15'	12.5'	9 1/2"					.59 lbs.
PU14-20	(1) 1/4" Swivel	B G R Y T	20'	17'	13"	3/8"	1/4"	2 1/2"	145 PSI	.74 lbs.
PU14-25	B= (2) 1/4" Swivel		25'	20'	16"					.88 lbs.
PU14-30	6= (2) 3/8" Rigid		30'	25.5'	19"					1.05 lbs.
PU14-50	— = (2) 1/4" Rigid		50'	42.5'	32 1/2"					1.50 lbs.
PU516-10	— = (2) 3/8" Rigid		10'	8'	7 1/2"					.68 lbs.
PU516-15	— = (2) 3/8" Rigid		15'	12.5'	11 1/2"					.89 lbs.
PU516-20	A= (1) 3/8" Rigid & (1) 3/8" Swivel	B G R Y T	20'	17'	15"	15/32"	5/16"	2 15/16"	130 PSI	1.11 lbs.
PU516-25	B= (2) 3/8" Swivel		25'	20'	19"					1.32 lbs.
PU516-30	B= (2) 3/8" Swivel		30'	25.5'	23"					1.52 lbs.
PU38-10	4= (2) 1/4" Rigid		10'	8'	5 1/2"					1.00 lbs.
PU38-15	— = (2) 3/8" Rigid		15'	12.5'	8 1/2"					1.40 lbs.
PU38-20	— = (2) 3/8" Rigid		20'	17'	11"					1.85 lbs.
PU38-25	A= (1) 3/8" Rigid & (1) 3/8" Swivel	B G R Y T	25'	20'	14"	9/16"	3/8"	4 1/8"	135 PSI	2.25 lbs.
PU38-30	B= (2) 3/8" Swivel		30'	25.5'	17"					2.63 lbs.
PU38-50	B= (2) 3/8" Swivel		50'	42.5'	27 1/2"					3.23 lbs.

Variations Available:

Colors • Printing • Packaging

* In addition to color choice, select fittings for both ends of the coil.

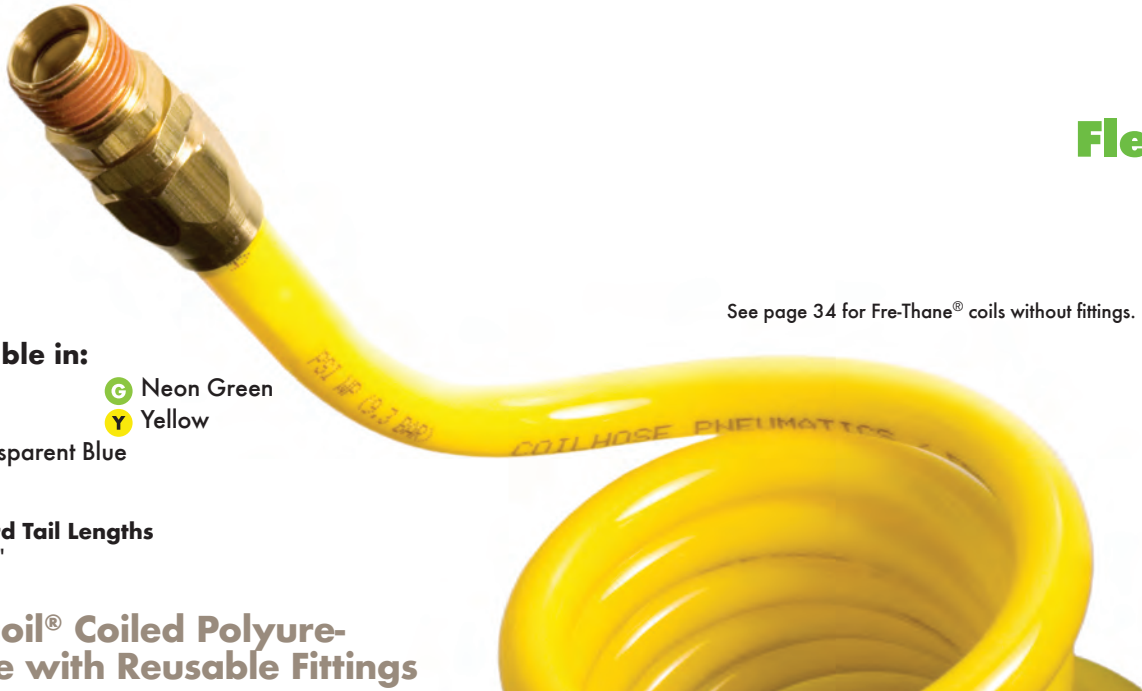

See page 34 for Fre-Thane® coils without fittings.

Available in:

- B Blue
- R Red
- T Transparent Blue
- G Neon Green
- Y Yellow

Standard Tail Lengths
8" and 16"

Flexcoil® Coiled Polyurethane with Reusable Fittings

Part Number, Fitting & Color Code	Fitting Options	Standard Colors	Material Length	Working Length	Retracted Length	OD	ID	Coil OD	Working Pressure	Weight
PR532-10	---		10'	8'	7"					.29 lbs.
PR532-15	---		15'	12.5'	9 1/2"					.37 lbs.
PR532-20	B= (2) 1/4" Swivel	B G R Y T	20'	17'	12 1/2"	1/4"	.160"	1 1/2"	150 PSI	.46 lbs.
PR532-25	---		25'	20'	15 1/2"					.54 lbs.
PR532-30	---		30'	25.5'	19"					.62 lbs.
PR316-5	---		5'	4'	2"					.23 lbs.
PR316-10	---		10'	8'	6"					.34 lbs.
PR316-15	B= (2) 1/4" Swivel	B G R Y T	15'	12.5'	10 1/4"	5/16"	3/16"	1 7/8"	160 PSI	.46 lbs.
PR316-20	---		20'	17'	14 1/2"					.56 lbs.
PR316-25	---		25'	20'	18 1/2"					.68 lbs.
PR14-5	---		5'	4'	2 1/2"					.26 lbs.
PR14-10	---		10'	8'	6"					.41 lbs.
PR14-15	—= (2) 1/4" Rigid		15'	12.5'	9 1/2"					.59 lbs.
PR14-20	A= (1) 1/4" Rigid	B G R Y T	20'	17'	13"	3/8"	1/4"	2 1/2"	145 PSI	.74 lbs.
PR14-25	(1) 1/4" Swivel		25'	20'	16"					.88 lbs.
PR14-30	B= (2) 1/4" Swivel		30'	25.5'	19"					1.05 lbs.
PR14-50	---		50'	42.5'	32 1/2"					1.50 lbs.
PR516-10	---		10'	8'	7 1/2"					.68 lbs.
PR516-15	---		15'	12.5'	11 1/2"					.89 lbs.
PR516-20	4B= (2) 1/4" Swivel	B G R Y T	20'	17'	15"	15/32"	5/16"	2 15/16"	130 PSI	1.11 lbs.
PR516-25	B= (2) 3/8" Swivel		25'	20'	19"					1.32 lbs.
PR516-30	---		30'	25.5'	23"					1.52 lbs.
PR38-10	4= (2) 1/4" Rigid		10'	8'	5 1/2"					1.00 lbs.
PR38-15	4A= (1) 1/4" Rigid		15'	12.5'	8 1/2"					1.40 lbs.
PR38-20	(1) 1/4" Swivel		20'	17'	11"					1.85 lbs.
PR38-25	4B= (2) 1/4" Swivel	B G R Y T	25'	20'	14"	9/16"	3/8"	4 1/8"	135 PSI	2.25 lbs.
PR38-30	—= (2) 3/8" Rigid		30'	25.5'	17"					2.63 lbs.
PR38-50	A= (1) 3/8" Rigid		50'	42.5'	27 1/2"					3.23 lbs.
PR12-10	(1) 3/8" Swivel		10'	8'	7"					2.14 lbs.
PR12-15	---		15'	12.5'	11 3/4"					2.95 lbs.
PR12-20	B= (2) 1/2" Swivel	B G R Y T	20'	17'	16 1/2"	3/4"	.467"	4.5"	155 PSI	3.77 lbs.
PR12-25	---		25'	20'	23"					4.60 lbs.
PR12-30	---		30'	25.5'	28"					5.35 lbs.
PR12-50	---		50'	42.5'	40"					7.75 lbs.

Colors • Printing • Packaging

* In addition to color choice, select fittings for both ends of the coil.

US Toll Free: 888-373-9233

Fre-Thane® Polyurethane Coils



Fre-Thane® polyurethane coils possess outstanding memory, a soft feel and superior flexibility. These coils are extraordinarily tough and resistant to abrasion, overstretching, kinking and repeated flexing.

Variations are easy. If you don't see the color or length that you want, just ask us. We can configure Fre-Thane® Coils to perfectly match your requirements.

Specifications

Temperature Range

-40°F to +165°F

Vacuum Rating

To 28" Hg.

Diameter Tolerances

±.005"

Working Pressure

3:1 Safety Factor

UV Stabilized

95A & 85A

Resin Compliance

See Page 8 for Fre-Thane Compliances

Suggested Fittings

Barb, Push-In (95A)

Standard Tail Lengths

8" and 16"

Fre-Thane® Single Tube Polyurethane Coils

Part Number & Color Code	OD	ID	DUR	Standard Colors	Working Pressure		Material Length	Working Length	Retracted Length	Coil ID
					75°F/25°C	150°F/65°C				
1W-013-___	1/8"	.066"	85A	01 02 04 05 06 07 08 09 10 11 12 14 25 26 27 28 29 32 45 46	115 PSI	45 PSI	10'	8'	8"	3/8"
1W-025-___	1/4"	1/8"	85A	01 02 04 05 06 07 08 09 10 11 12 25 26 27 28 29 32 46	125 PSI	50 PSI	10'	8'	8"	3/4"
1W-132-___	1/4"	.159"	90A	01 07 08 10 14 25 27	115 PSI	45 PSI	10'	8'	9"	3/4"
1W-005-___	3/8"	.245"	90A	01 05 07 10 11 25 27	105 PSI	40 PSI	10'	8'	7.5"	1-1/4"
1Z-005-___					25'	20'	22"			
1W-151-___	1/4"	.16"	95A	01 04 05 06 07 08 09 10 11 12 25 26 27 28 46	150 PSI	60 PSI	10'	8'	7"	1"
1X-151-___	1/4"	.16"	95A				15'	12.5'	10"	
1Y-151-___	1/4"	.16"	95A				20'	17'	14.5"	
1Z-151-___	1/4"	.16"	95A				25'	20'	19.5"	
1W-152-___	3/8"	.245"	95A	01 04 05 06 07 08 10 11 25 26 27 28 37 46	130 PSI	60 PSI	10'	8'	6"	1-3/4"
1X-152-___	3/8"	.245"	95A				15'	12.5'	9"	
1Y-152-___	3/8"	.245"	95A				20'	17'	13"	
1Z-152-___	3/8"	.245"	95A				25'	20'	16"	

Variations Available: Colors • Cutting • Bonding • Printing • Packaging • Sizes

Metric Fre-Thane® Single Tube Polyurethane Coils

Part Number & Color Code	OD	ID	DUR	Standard Colors	Working Pressure		Material Length	Working Length	Retracted Length	Coil ID	Tail Length
					75°F/25°C	150°F/65°C					
1W-156-___	4mm	2.4mm	95A	01 02 04 05 06 07 08 09 10	165 PSI	85 PSI	3.05 M	2.6 M	133.4mm	19.1mm 203.4/406.4mm	
1X-156-___	4mm	2.4mm	95A	11 12 25 26 27 28 29 37			4.57 M	3.8 M	216mm		
1Y-156-___	4mm	2.4mm	95A				6.1 M	5.2 M	292mm		
1Z-156-___	4mm	2.4mm	95A				7.62 M	6.4 M	381mm		
1W-158-___	6mm	4mm	95A	01 04 05 06 07 08 09 10 11 25 26 27 28 37	135 PSI	65 PSI	3.05 M	2.6 M	139.7mm	25.4mm 203.4/406.4mm	
1X-158-___	6mm	4mm	95A				4.57 M	3.8 M	241.3mm		
1Y-158-___	6mm	4mm	95A				6.1 M	5.2 M	330mm		
1Z-158-___	6mm	4mm	95A				7.62 M	6.4 M	419mm		
1W-159-___	8mm	5mm	95A	01 05 06 07 08 10 11 25 27 37 46	160 PSI	75 PSI	3.05 M	2.6 M	152.4mm	31.8mm 203.4/406.4mm	
1X-159-___	8mm	5mm	95A				4.57 M	3.8 M	254mm		
1Y-159-___	8mm	5mm	95A				6.1 M	5.2 M	343mm		
1Z-159-___	8mm	5mm	95A				7.62 M	6.4 M	444.5mm		
1W-160-___	10mm	6.5mm	95A	01 05 06 07 08 10 27	135 PSI	70 PSI	3.05 M	2.6 M	139.7mm	44.5mm 203.4/406.4mm	
1X-160-___	10mm	6.5mm	95A				4.57 M	3.8 M	228.6mm		
1Y-160-___	10mm	6.5mm	95A				6.1 M	5.2 M	317.5mm		
1Z-160-___	10mm	6.5mm	95A				7.62 M	6.4 M	406.4mm		

Variations Available: Colors • Cutting • Bonding • Printing • Packaging • Sizes

Flexible PVC

Freelin-Wade's non-reinforced flexible PVC uses a non-phthalate plasticizer. We pioneered the use of this environmentally friendly material in the plastic tubing industry.

Freelin-Wade's PVC has a smooth interior and exterior which prevents sediment accumulation, making it well-suited for the food & beverage, medical and pharmaceutical industries.

Our reinforced PVC hose has an open weave innerbraid for increased working pressures up to 250 PSI. The smooth-bore, full-flow I.D. dimensions are sized to fit standard commercial barbed fittings.



Specifications

Temperature Range

All Diameters:
-30 °F to +150 °F

Vacuum Rating

Reinforced PVC:
To 18" Hg.

Hardness

65A Durometer
80A Durometer

Working Pressure

3:1 Safety Factor

Resin Compliance Non-Reinforced Only

FDA for Food Contact
CA Prop. 65
Meets USPVI
Testing Requirements

Suggested Fittings

Barb

Non-Phthalate Polyvinyl Chloride: 65A PVC

Part Number & Color Code	Packaging Unit Size	OD	ID	Wall	Standard Color	Working Pressure		lbs./100'	Bend Radius	Fitting
						75°F/25°C	150°F/65°C			
1J-721-10	100' Bag	1/8"	1/16"	.031"	10	85 PSI	10 PSI	.51	1/4"	B
1A-721-10	2500' Reel									
1J-722-10	100' Bag	1/4"	1/8"	.062"	10	70 PSI	10 PSI	2	3/8"	B
1A-722-10	1000' Reel									
1J-723-10	100' Bag	5/16"	3/16"	.062"	10	50 PSI	5 PSI	2.6	5/8"	B
1A-723-10	500' Reel									

Variations Available:

Colors • Cutting • Bonding • Printing • Packaging • Sizes

Non-Phthalate Polyvinyl Chloride: 80A PVC

Part Number & Color Code	Packaging Unit Size	OD	ID	Wall	Standard Color	Working Pressure		lbs./100'	Bend Radius	Fitting
						75°F/25°C	150°F/65°C			
1J-700-10	100' Bag	1/8"	1/16"	.031"	10	145 PSI	20 PSI	.51	3/8"	B
1A-700-10	2500' Reel									
1J-701-10	100' Bag	1/4"	1/8"	.062"	10	165 PSI	25 PSI	2	1/2"	B
1A-701-10	1000' Reel									
1J-702-10	100' Bag	1/4"	0.17"	0.04	10	95 PSI	10 PSI	1.75	1"	B
1A-702-10	1000' Reel									
1J-703-10	100' Bag	5/16"	3/16"	.062"	10	110 PSI	15 PSI	2.6	5/8"	B
1A-703-10	500' Reel									
1J-704-10	100' Bag	3/8"	1/4"	.062"	10	91 PSI	15 PSI	3.25	7/8"	B
1A-704-10	500' Reel									
1J-705-10	100' Bag	1/2"	3/8"	.062"	10	57 PSI	10 PSI	4.55	1-3/4"	B
1A-705-10	200' Reel									
1A-706-10	100' Reel	3/4"	1/2"	.125"	10	63 PSI	15 PSI	13.01	1-1/4"	B

Variations Available:

Colors • Cutting • Bonding • Printing • Packaging • Sizes

US Toll Free: 888-373-9233

19

Reinforced Polyvinyl Chloride: PVC

Part Number & Color Code	Packaging Unit Size	OD	ID	Wall	Available Only in Clear	Working Pressure		lbs./100'	Bend Radius	Fitting
						75°F/25°C	150°F/65°C			
1J-750-10	100' Length	.438"	1/4"	.094"	10	250 PSI	125 PSI	5.38	1"	B
1J-751-10	100' Length	.594"	3/8"	.110"	10	225 PSI	110 PSI	8.83	1-1/4"	B
1J-752-10	100' Length	.750"	1/2"	.125"	10	200 PSI	100 PSI	13.01	2-1/4"	B
1J-753-10	100' Length	1.025"	3/4"	.137"	10	150 PSI	75 PSI	20.32	3-1/4"	B
1J-754-10	100' Length	1.312"	1"	.156"	10	125 PSI	60 PSI	30.01	5"	B
1J-755-10	100' Length	1.656"	1-1/4"	.203"	10	100 PSI	50 PSI	49.11	6-1/2"	B
1J-756-10	100' Length	1.937"	1-1/2"	.218"	10	100 PSI	50 PSI	62.52	8-1/2"	B
1J-757-10	100' Length	2.5"	2"	.250"	10	75 PSI	35 PSI	93.66	10"	B

Variations Available: Cutting • Printing • Bonding • Packaging • Sizes

Polyethylene & Liquiflex-POE™

Specifications

Temperature Range

LLDPE & Liquiflex:
-40°F to +150°F

Vacuum Rating

All: To 28" Hg.

Diameter Tolerance

LLDPE: ±.004"
Liquiflex: ±.005"

Hardness

LLDPE: 50 Shore D
Liquiflex: 92A

Tube Markings

LLDPE FW Specifications

Working Pressure

LLDPE & Liquiflex:
3:1 Safety Factor

Resin Compliance

LLDPE: FDA, NSF51
Liquiflex: FDA

Linear Low Density Polyethylene – LLDPE

LLDPE's greatest advantage over low density polyethylene is its superior environmental stress crack resistance (ESCR). Environmental stresses that can shorten the service life of tubing include: chemical exposure, aging, connection to barb-type fittings, or high vibration connections with compression fittings. All colors comply with FDA regulation 21 CFR 177.1520(c) for food contact applications. Freelin-Wade has chosen to standardize on linear low density polyethylene and no longer offers low density polyethylene.

Features

- Superior stress and crack resistance
- Tasteless and odorless
- Impermeable to gasses and moisture
- Superior dielectric properties

Polyethylene (Linear Low Density: LLDPE)

Part Number & Color Code	Packaging Unit Size	OD	ID	Wall	Standard Colors	Working Pressure		lbs./100'	Bend Radius	Fitting
						75°F/25°C	150°F/65°C			
1J-109-___	100' Bag									
1L-109-___	250' Box									
1C-109-___	500' Reel	1/8"	.062"	.031"	01 04 05 06 07 08 09 10	305 PSI	120 PSI	.40	1/2"	PI, C
1B-109-___	1000' Reel									
1A-109-___	2500' Reel									
1J-189-___	100' Bag									
1L-189-___	250' Box									
1C-189-___	500' Reel	5/32"	.106"	.025"	01 05 06 07 08 10	175 PSI	70 PSI	.46	1"	PI, C
1B-189-___	1000' Reel									
1A-189-___	2500' Reel									
1J-048-___	100' Bag									
1B-048-___	500' Reel	1/4"	.170"	.040"	01 04 05 06 07 08 09 10 12	200 PSI	80 PSI	1.2	1-1/4"	PI, C
1A-048-___	1000' Reel									
1J-077-___	100' Bag									
1A-077-___	500' Reel	5/16"	.187"	.062"	01 05 06 07 08 10	230 PSI	90 PSI	2.5	1-1/2"	PI, C
1J-074-___	100' Bag									
1A-074-___	500' Reel	3/8"	.250"	.062"	01 04 05 06 07 08 09 10	190 PSI	75 PSI	2.76	2"	PI, C
1J-076-___	100' Bag									
1A-076-___	250' Reel	1/2"	.375"	.062"	01 05 06 07 08 09 10	135 PSI	55 PSI	3.87	2-1/2"	PI, C
1AA-076-___	500' Reel									
1A-086-___	100' Reel									
1AA-086-___	300' Reel	5/8"	.500"	.062"	01 10	100 PSI	40 PSI	5	3"	PI, C

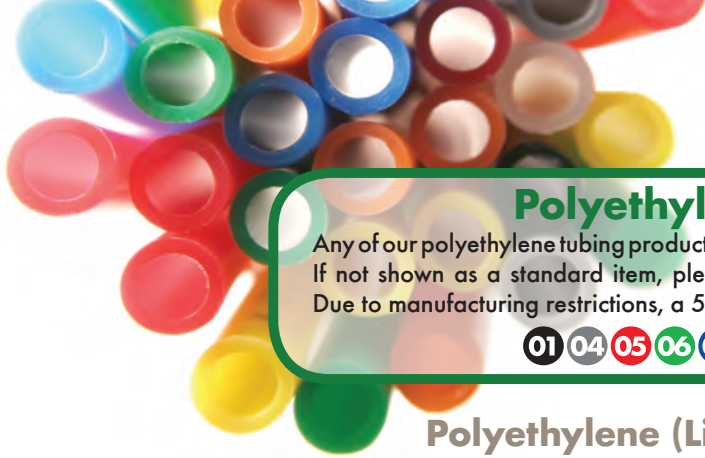

Polyethylene Colors

Any of our polyethylene tubing products are available in the colors shown below. If not shown as a standard item, please allow 4 weeks to fulfill your order. Due to manufacturing restrictions, a 5000ft order may be required.

01 04 05 06 07 08 09 10 12

Polyethylene (Linear Low Density: LLDPE)

Part Number & Color Code	Packaging Unit Size	OD mm	ID mm	Wall mm	Standard Colors	Working Pressure		lbs./100'	Bend Radius	Fitting
						75°F/25°C	150°F/65°C			
1J-189- ___	100' Bag									
1L-189- ___	250' Box									
1C-189- ___	500' Reel	4	2.7	.65	01 05 06 07 08 10	175 PSI	70 PSI	.46	25.2 mm	PI, C
1B-189- ___	1000' Reel									
1A-189- ___	2500' Reel									
1J-071- ___	100' Bag									
1B-071- ___	500' Reel	6	4	1	01 07 10	175 PSI	70 PSI	1.1	31.8 mm	PI, C
1A-071- ___	1000' Reel									
1J-072- ___	100' Bag									
1A-072- ___	500' Reel	8	6	1	01 05 07 10	140 PSI	55 PSI	1.5	38 mm	PI, C
1J-073- ___	100' Bag									
1A-073- ___	500' Reel	10	8	1	01 07 10	115 PSI	45 PSI	2.1	51 mm	PI, C
1J-075- ___	100' Bag									
1A-075- ___	250' Reel	12	9	1.5	01 07 10	135 PSI	55 PSI	3.44	63 mm	PI, C
1AA-075- ___	500' Reel									

Variations Available:

Colors • Cutting • Printing • Packaging • Sizes



Liquiflex-POE™

- Greater flexibility
- UV Resistant
- Makes an excellent coil
- Can be bonded

Freelin-Wade has developed a new polyolefin tube that is more flexible and abuse resistant than polyethylene. It has all of the chemical resistant properties of LLDPE and is an excellent choice for conveying liquids. Note that it has low pressure ratings, particularly in warm environments.

Liquiflex-POE™

Part Number & Color Code	Packaging Unit Size	OD	ID	Wall	Standard Colors	Working Pressure		lbs./100'	Bend Radius	Fitting
						75°F/25°C	150°F/65°C			
1J-961- ___	100' Bag									
1B-961- ___	500' Reel	1/4"	1/8"	.062"	01	125 PSI	75 PSI	1.52	.75"	B, PI, C
1A-961- ___	1000' Reel									
1J-962- ___	100' Bag									
1B-962- ___	500' Reel	1/4"	.170"	.040"	01 05	80 PSI	20 PSI	1.08	1.375"	B, PI, C
1A-962- ___	1000' Reel									
1J-963- ___	100' Bag									
1A-963- ___	500' Reel	3/8"	.245"	.062"	07 10	75 PSI	35 PSI	2.56	1.5"	B, PI, C
1J-964- ___	50' Bag									
1A-964- ___	250' Reel	1/2"	3/8"	.062"	01 05	60 PSI	25 PSI	3.52	2.75"	B, PI, C

Coiling • Colors • Cutting • Bonding • Printing • Packaging

US Toll Free: 888-373-9233

21

Nylon

Specifications

Temperature Range
-60°F to +200°F

Vacuum Rating
To 28" Hg

Diameter Tolerance
<1/2"± .004"
>1/2"± .005"

Hardness
78 Rockwell R

Tube Markings
FW Specifications

Working Pressure
4:1 Safety Factor

UV Stabilized
Yes

Resin Compliance
Meets UL94HB
Testing Requirements

Suggested Fittings
Push-In, Compression

Nylon tubing (also referred to as polyamide) can withstand higher temperatures, making it an ideal choice for a wide variety of applications. When compared to other Nylon resins, Freelin-Wade's tubing allows for a lighter weight wall, greater flexibility and smaller bend radius. It is also more corrosion resistant than other types of Nylon tubing because of its resistance moisture absorption. It's heat and UV stabilization makes it resistant to stress-cracking, so it works well in sunny areas. It is chemical resistant which makes it a good choice in areas where exposure to certain chemicals is a possibility.

Freelin-Wade manufactures nylon tubing from a variety of resins and there are any number of variations possible. We are happy to match any color you need, configure a coil, bond two tubes, print and cut to length. Freelin-Wade can make a nylon tube to meet your needs.

Features

- Strong, lightweight and flexible.
- Dimensionally stable.
- Heat and light stabilized.
- Resistant to corrosion and stress-cracking.

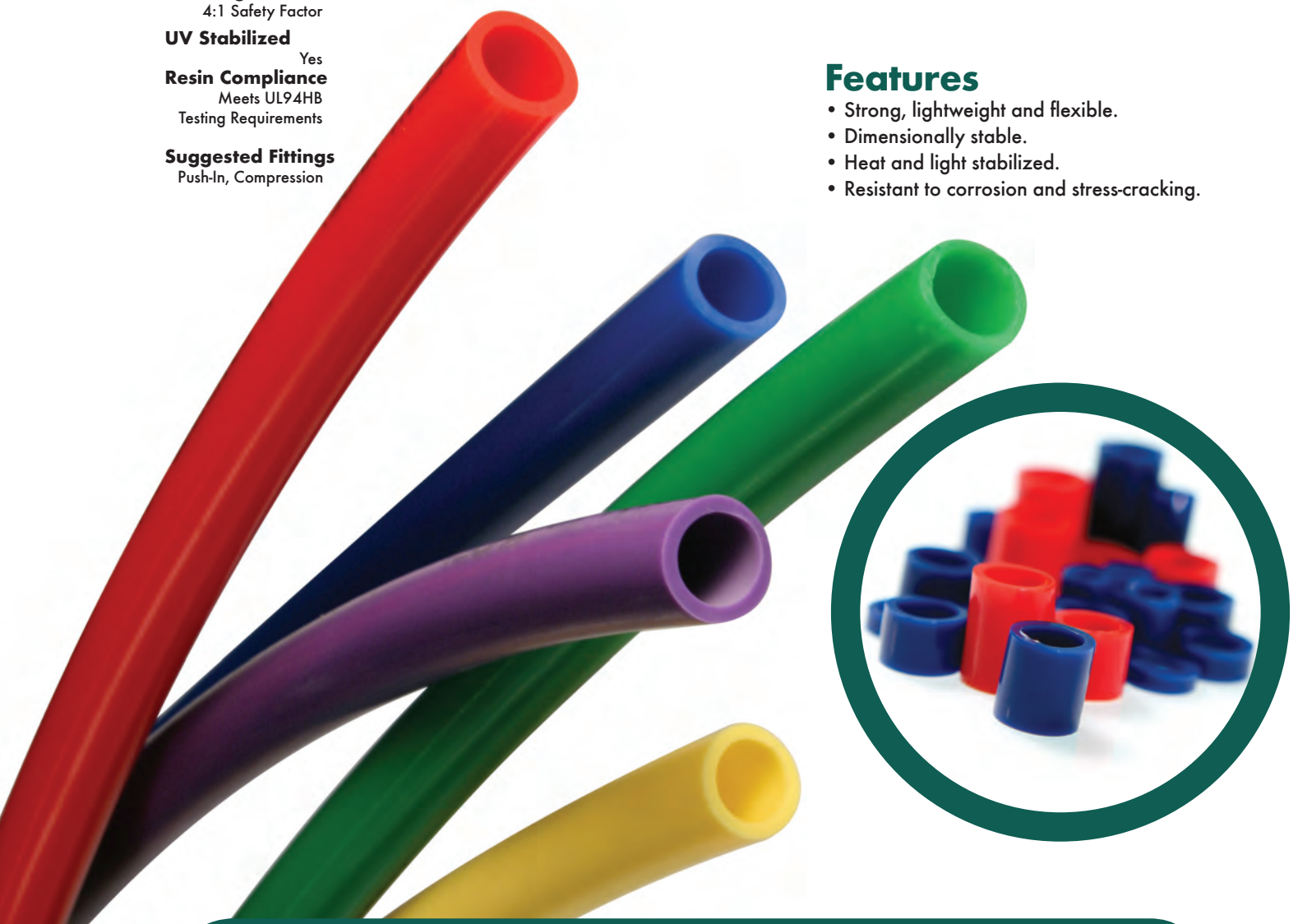

Nylon Colors

Any of our nylon tubing products listed on page 15 are available in the colors shown below. If not shown as a standard item, please allow 4 weeks to fulfill your order.



Nylon

Part Number & Color Code	Packaging Unit Size	OD	ID	Wall	Standard Colors	Working Pressure		lbs./100'	Bend Radius	Fitting
						75°F/25°C	150°F/65°C			
1J-247- 1A-247-	100' Bag 2500' Reel	1/8"	.079"	.023"	01 10	420 PSI	250 PSI	.35	3/8"	PI, C
1J-200- 1C-200- 1B-200- 1A-200-	100' Bag 500' Reel 1000' Reel 2500' Reel	1/8"	.093"	.016"	01 05 06 07 08 10	270 PSI	160 PSI	.25	1/2"	PI, C
1J-201- 1C-201- 1B-201- 1A-201-	100' Bag 500' Reel 1000' Reel 2500' Reel	5/32"	.106"	.025"	01 03 05 06 07 08 09 10 12	350 PSI	210 PSI	.51	1/2"	PI, C
1J-202- 1B-202- 1A-202-	100' Bag 500' Reel 2000' Reel	3/16"	.138"	.025"	01 05 06 07 10	260 PSI	160 PSI	.55	5/8"	PI, C
1J-214- 1A-214-	100' Bag 1000' Reel	1/4"	.125"	.062"	01 10	590 PSI	350 PSI	1.77	3/8"	PI, C
1J-203- 1B-203- 1A-203-	100' Bag 500' Reel 1000' Reel	1/4"	.170"	.040"	01 03 05 06 07 08 09 10	330 PSI	200 PSI	1.27	3/4"	PI, C
1J-204- 1B-204- 1A-204-	100' Bag 500' Reel 1000' Reel	1/4"	.180"	.035"	01 05 06 07 08 09 10	290 PSI	170 PSI	1.13	1"	PI, C
1J-205- 1A-205-	100' Bag 500' Reel	5/16"	.232"	.040"	01 05 06 07 08 10	240 PSI	140 PSI	1.64	1-1/2"	PI, C
1J-206- 1A-206-	100' Bag 500' Reel	3/8"	.275"	.050"	01 05 06 07 08 09 10	250 PSI	150 PSI	2.45	1-1/2"	PI, C
1J-207- 1A-207- 1AA-207-	100' Bag 250' Reel 500' Reel	1/2"	.375"	.062"	01 05 06 07 08 10	240 PSI	140 PSI	4.12	2-1/4"	PI, C
1J-213- 1AA-213-	50' Bag 250' Reel	5/8"	1/2"	.062"	01 10	170 PSI	100 PSI	5.30	3-1/4"	PI, C

Metric Sizes

Part Number & Color Code	Packaging Unit Size	OD mm	ID mm	Wall mm	Standard Colors	Working Pressure		lbs./100'	Bend Radius	Fitting
						75°F/25°C	150°F/65°C			
1J-246- 1C-246- 1B-246- 1A-246-	100' Bag 500' Reel 1000' Reel 2500' Reel	3	1.8	.6	10	410 PSI	240 PSI	.33	6.3 mm	PI, C
1J-201- 1C-201- 1B-201- 1A-201-	100' Bag 500' Reel 1000' Reel 2500' Reel	4	2.7	.65	01 03 05 06 07 08 09 10 12	350 PSI	210 PSI	.51	12.7 mm	PI, C
1J-241- 1A-241-	100' Bag 1000' Reel	5	3	1	01 05 06 07 08 10	420 PSI	250 PSI	.94	9.5 mm	PI, C
1J-242- 1B-242- 1A-242-	100' Bag 500' Reel 1000' Reel	6	4	1	01 05 06 07 08 09 10	340 PSI	200 PSI	1.17	17 mm	PI, C
1J-243- 1A-243-	100' Bag 500' Reel	8	6	1	01 05 06 07 08 10	250 PSI	150 PSI	1.64	38 mm	PI, C
1J-244- 1A-244-	100' Bag 500' Reel	10	8	1	01 03 10	190 PSI	110 PSI	2.11	51 mm	PI, C
1J-245- 1A-245- 1AA-245-	100' Bag 250' Reel 500' Reel	12	10	1	01 10	150 PSI	90 PSI	2.55	76 mm	PI, C

Variations Available: Coiling • Colors • Cutting • Bonding • Printing • Packaging

Nylon: D.O.T., High Pressure, & Super Soft

Specifications

Temperature Range

HP: -60°F to +200°F
 SS: -40°F to +180°F
 DOT: -60°F to +200°F

Vacuum Rating

All: To 28" Hg.

Diameter Tolerances

HP: < OD .5": ±.004"
 > OD .5": ±.005"
 SS: ±.004"
 DOT: 1/8" - 1/4": ±.003"
 5/16": ±.004"

Hardness

HP: 108 Rockwell R
 SS: 57 Shore D
 DOT: 78 Rockwell R

Tube Markings

HP & SS: FW Specs
 DOT: DOT Specs

Working Pressure

4:1 Safety Factor

UV Stabilized

All: Yes

Resin Compliance

Meets UL94HB Testing Requirements

Suggested Fittings

Push-In, Compression

D.O.T. Nylon 11

DO.T. tubing is made using our standard Nylon. Type "A" Air Brake tubing is ideal for use on vehicles for instrumentation and pneumatic accessories connected to the air brake system. Type "A" Air Brake tubing is non-reinforced and meets SAE J844 specifications and is available in a variety of colors.



D.O.T. Nylon

High Pressure Nylon 11

Freelin-Wade's High Pressure Nylon tubing is made from a semi-rigid compound that has outstanding tensile strength and chemical resistance, making it the ideal choice for chemical and oil processing lines, tool lubricating systems and other applications that require a high quality Nylon material with much higher burst ratings.

Super Soft Nylon 11

Freelin-Wade's Super Soft Nylon 11 tubing is formulated with a special compound to significantly increase flexibility while retaining the outstanding qualities of our standard Nylon tubing. This advantage makes our Super Soft Nylon 11 the ideal choice where media and environmental conditions make polyurethane impractical.

- More flexible than standard Nylon tubing
- Heat and light stabilized.

D.O.T. Tubing

Part Number & Color Code	Packaging Unit Size	OD	Wall	Standard Colors	Burst Pressure 75°F/25°C	lbs./100'	Bend Radius	Fitting
1J-220- ____	100' Bag	1/8"	.023	01 05 07 08 09	1000 PSI	.34	3/8"	PI, C
1C-220- ____	500' Reel							
1B-220- ____	1000' Reel							
1A-220- ____	2000' Reel							
1J-221- ____	100' Reel	5/32"	.032	01 05 06 07 09	1200 PSI	.57	1/2"	PI, C
1C-221- ____	500' Reel							
1B-221- ____	1000' Reel							
1A-221- ____	2000' Reel							
1J-223- ____	100' Bag	1/4"	.040	01 05 06 07 08 09	1200 PSI	1.21	1"	PI, C
1B-223- ____	500' Reel							
1A-223- ____	1000' Reel							
1J-225- ____	100' Bag	5/16"	.040	01 05 07 09	1000 PSI	1.57	1-1/4"	PI, C
1A-225- ____	500' Reel							

Variations Available: Coiling • Colors • Cutting • Bonding • Printing • Packaging • Sizes

High Pressure Nylon 11

Part Number & Color Code	Packaging Unit Size	OD	ID	Wall	Standard Colors	Working Pressure		lbs./100'	Bend Radius	Fitting
						75°F/25°C				
1J-280- ___ 100' Bag										
1B-280- ___ 500' Reel		1/8"	.073"	.026"	10		800 PSI	.39	5/16"	PI, C
1A-280- ___ 2500' Reel										
1J-281- ___ 100' Bag										
1B-281- ___ 500' Reel		3/16"	.109"	.039"	10		800 PSI	.88	7/16"	PI, C
1A-281- ___ 2000' Reel										
1J-282- ___ 100' Bag										
1B-282- ___ 500' Reel		1/4"	.150"	.050"	01 10		800 PSI	1.51	9/16"	PI, C
1A-282- ___ 1000' Reel										
1J-283- ___ 100' Bag										
1A-283- ___ 500' Reel		3/8"	.225"	.075"	10		800 PSI	3.39	1"	PI, C
1A-284- ___ 250' Reel										
1AA-284- ___ 500' Reel		1/2"	.350"	.075"	10		530 PSI	4.81	2"	PI, C

Variations Available:

Coiling • Colors • Cutting • Printing • Packaging • Sizes

Super Soft Nylon

Super Soft Nylon 11

Part Number & Color Code	Packaging Unit Size	OD	ID	Wall	Standard Colors	Working Pressure		lbs./100'	Bend Radius	Fitting	
						75°F/25°C	150°F/65°C				
1J-260- ___ 100' Bag											
1C-260- ___ 500' Reel		1/8"	.093"	.016"	01 10		200 PSI	120 PSI	.25	9/16"	PI, C
1B-260- ___ 1000' Reel											
1A-260- ___ 2500' Reel											
1J-261- ___ 100' Bag											
1C-261- ___ 500' Reel		5/32"	.106"	.025"	01 10		220 PSI	130 PSI	.45	9/16"	PI, C
1B-261- ___ 1000' Reel											
1A-261- ___ 2500' Reel											
1J-264- ___ 100' Bag											
1B-264- ___ 500' Reel		1/4"	.180"	.035"	01 10		180 PSI	110 PSI	1.04	1"	PI, C
1A-264- ___ 1000' Reel											
1J-265- ___ 100' Bag											
1A-265- ___ 500' Reel		5/16"	.232"	.040"	01 10		170 PSI	100 PSI	1.52	1-1/4"	PI, C
1J-266- ___ 100' Bag											
1A-266- ___ 500' Reel		3/8"	.275"	.050"	01 10		160 PSI	90 PSI	2.26	1-5/8"	PI, C
1J-267- ___ 100' Bag											
1AA-267- ___ 500' Reel		1/2"	3/8"	.062"	01 10		140 PSI	80 PSI	3.80	2-1/2"	PI, C

Metric Sizes

Part Number & Color Code	Packaging Unit Size	OD mm	ID mm	Wall mm	Standard Colors	Working Pressure		lbs./100'	Bend Radius	Fitting	
						75°F/25°C	150°F/65°C				
1J-272- ___ 100' Bag											
1B-272- ___ 500' Reel		6	4	1	01 10		240 PSI	140 PSI	1.10	19.0 mm	PI, C
1A-272- ___ 1000' Reel											
1J-273- ___ 100' Bag											
1A-273- ___ 500' Reel		8	6	1	01 10		160 PSI	100 PSI	1.70	38.0 mm	PI, C
1J-274- ___ 100' Bag											
1A-274- ___ 500' Reel		10	8	1	01 10		120 PSI	70 PSI	2.20	28.6 mm	PI, C
1J-275- ___ 100' Bag											
1AA-275- ___ 500' Reel		12	10	1	01 10		90 PSI	50 PSI	2.80	38.0 mm	PI, C

Variations Available:

Coiling • Colors • Cutting • Bonding • Printing • Packaging

US Toll Free: 888-373-9233

25

Nylon Coiled Hose

Freelin-Wade's Nylon coiled tubing is tough and abrasion resistant. The hoses are fitted with durable brass male swivel compression fittings and spring guards that are preassembled on each hose end. Bulk hoses are offered in 100 foot lengths for users wanting to assemble their own hoses.

Our Nylon Twin Hose (pictured below) has all of the same features but with the added benefit of two hoses bonded together. An intermittent bond allows for easy fitting installation and eliminates taping or tie wrapping hoses together in twin line applications. One line is yellow and the second is a natural translucent color which allows for visual flow verification. Contact Customer Service for more information.

The difference between the Self-Storing Hose and the Mini Coils is that the Self-Storing Hose includes fittings.



Features

- Economical and lightweight.
- Self retracting.
- Resists oil, grease and corrosion.
- Pre-sealed threads on swivel fittings.

Specifications

Temperature Range
-60°F to +180°F

Vacuum Rating
To 28" Hg.

Diameter Tolerances
±.004"

Working Pressure
4:1 Safety Factor

Tube Markings
FW Specifications

Resin Compliance
Meets UL94HB
Testing Requirements



Nylon Self-Storing Hose

Part Number & Color Code	OD	ID	Working Pressure		Material Length	Working Length	Retracted Length	Coil OD	MPT Fitting	Approx. Weight
			75°F/25°C	150°F/65°C						
N14-12B					12'	9'	5-1/4"		1/4"	.375 lbs.
N14-25B	.309"	1/4"	185 PSI	110 PSI	25'	19'	10"	3-1/2"	1/4"	.62 lbs.
N14-50B					50'	37.5'	19-3/4"		1/4"	.937 lbs.
N14-100					100'	75'	39-1/2"		none	1.37 lbs.
N38-12B					12'	9'	4-1/2"		3/8"	.687 lbs.
N38-25B	.470"	3/8"	165 PSI	100 PSI	25'	19'	9"	5-5/8"	3/8"	1.62 lbs.
N38-50B					50'	37.5'	18-1/4"		3/8"	1.75 lbs.
N38-100					100'	75'	36-3/4"		none	4 lbs.
N12-12B					12'	9'	4-1/4"		1/2"	.375 lbs.
N12-25B	.625"	1/2"	170 PSI	110 PSI	25'	19'	8-1/2"	9"	1/2"	.562 lbs.
N12-50B					50'	37.5'	15-1/2"		1/2"	.937 lbs.
N12-100					100'	75'	31-1/2"		none	1.37 lbs.

Variation Available:

Packaging

Nylon Mini Coils

Specifications

Temperature Range
-60°F to +180°F

Vacuum Rating
To 28" Hg.

Tube Diameter Tolerances
±.004

Tube Markings
FW Specifications

Standard Tail Lengths
2" on each end

Freelin-Wade's Nylon Mini Coils have two inch integral pigtails on each end. This allows for instant push-to-connect or standard compression fittings to be used. These small diameter coils are flexible and easy to handle. They are ideal for small pneumatic tools and robotic applications. Our Mini Coils are made from tough abrasion resistant Nylon.

Variations are easy. If you don't see the color or length that you want, just ask us. We can configure Nylon Mini Coils to perfectly match your requirements.



Nylon Mini Coils

Part Number & Color Code	OD	ID	Standard Colors	Working Pressure		Material Length	Working Length	Retracted Length	Coil OD
				75°F/25°C	150°F/65°C				
N1063-___						5.4'	4'	3"	
N1066-___	5/32"	.106"	01 03 05 06 07 08 09 10	298 PSI	179 PSI	13.5'	10.5'	6"	1.312"
N10612-___						25'	20'	12"	
N10624-___						47'	37.5'	24"	
N1706-___						9'	7'	6"	
N1709-___						15'	12'	9"	
N17012-___	1/4"	.170"	01 03 05 06 07 08 09 10	280 PSI	170 PSI	18'	14'	12"	1.750"
N17024-___						35'	28'	25"	
N17036-___						56'	44.5'	36"	

Variations Available:

Colors • Printing • Packaging • Sizes

Coil Terminology

Coil Diameter plays a very significant role in retractability. The smaller and tighter the coil diameter, the snappier and more retractable the coil becomes.

Working Length is based on how far a coil can be stretched and used comfortably. Tail length is factored into working length.

Retracted Length is the length of the coiled section of the body of the coil. It does not include the length of tails.

Tails (or Pigtails) make it easier to use a coil. Our standard tail lengths are 8" and 16". Coils with longer or shorter tails are available.

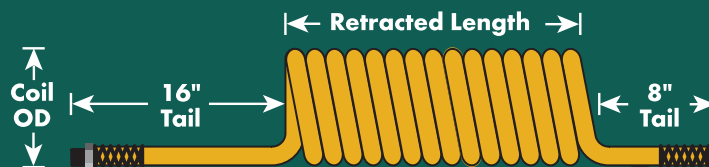

US Toll Free: 888-373-9233

Kynar® PVDF & FEP

Specifications

Temperature Range
-40° F to +180° F

Vacuum Rating
To 28" Hg

Diameter Tolerance
±.005"

Hardness
65 Shore D

Tube Markings
None

Working Pressure
4:1 Safety Factor

Resin Compliance
FDA, USPVI
UL 94 V0, NSF-51

Suggested Fittings
Push-In, Compression

Kynar® Polyvinylidene Fluoride – PVDF

Kynar® PVDF compound is an economical alternative to Teflon® (PTFE, PFA, and FEP) tubing for applications not requiring heat resistance. Kynar possesses excellent resistance to a wide range of chemicals. The high purity material is the ideal tubing for a variety of applications requiring an odorless and tasteless tube.

There are multiple grades of Kynar resins available. Some of these are used in rigid pipe applications. Freelin-Wade uses a flexible grade.

For more information about Kynar, refer to the Kynar Website: www.kynar.com
You can also refer to our Chemical Resistance Chart on page 38.

Features

Resists:

- Acids
 - Alcohol
 - Aliphatics
 - Aromatics
 - Mild Bases
 - Chloride
 - Halogen
 - Fungus
 - Out-gassing
 - Radiation
 - UV Light
- Sterilizable by Gamma Radiation or Ozone.
• Resists fungal growth per MS 810B, Method 508 testing.

Kynar

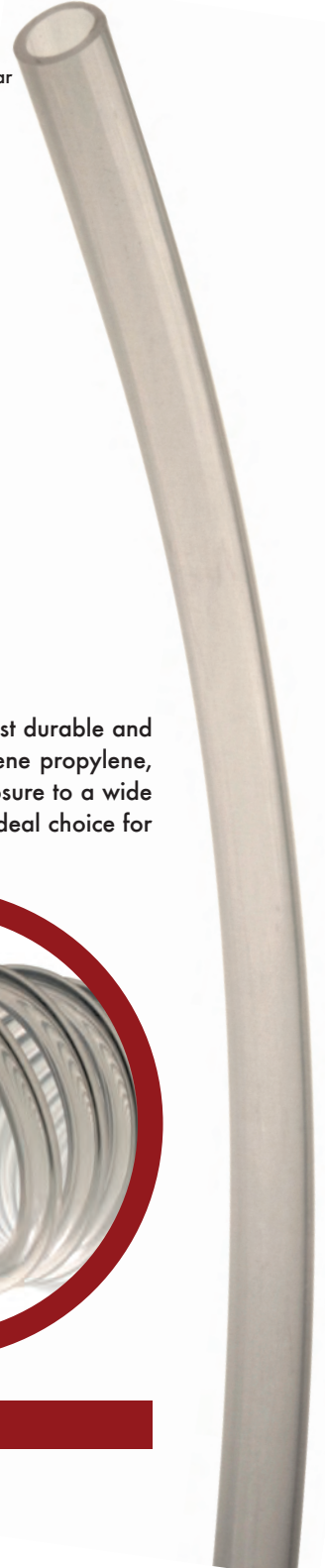

Specifications

Temperature Range
-100° F to +400° F
-73° to 204° C

Vacuum Rating
To 28" Hg

Diameter Tolerance
±.005"

Hardness
57 Shore D

Tube Markings
None

Working Pressure
5:1 Safety Factor

Resin Compliance
FDA Food Contact
UL 94 V0, USP VI
ASTM D 3296-03

Suggested Fittings
Flare, Compression,
Push-In

Fluorinated Ethylene Propylene – FEP

Freelin-Wade's FEP tubing (compare to DuPont's® Teflon®) is one of the most durable and versatile flexible plastic tubes that you can buy. FEP, or fluorinated ethylene propylene, is an economical choice for applications requiring chemical resistance or exposure to a wide range of temperatures. Freelin-Wade's FEP is extremely flexible, making it an ideal choice for self-retracting coils. FEP is also available in a variety of packaged lengths.

Applications include chemical processing, laboratory applications, medical devices, water purification, food processing and automotive paint spray.

Features

- 100% virgin grade high performance resin designed to resist stress cracking
- Low permeability
- High thermal stability and UV resistant
- Non-flammable/Self-extinguishing
- Superior electrical insulation properties
- Chemically inert to most industrial chemicals and solvents
- Available in colors



FEP
Coiling:
available
as a variation

Part Number & Color Code	Packaging Unit Size	OD	ID	Wall	Standard Colors	Working Pressure		lbs./100'	Bend Radius	Fitting									
						75°F/25°C	150°F/65°C												
1J-681- ___ 100' Bag	1C-681- ___ 500' Reel	1/8"	1/16"	.030"	10	300 PSI	125 PSI	0.71	3/16"	PI, C									
1B-681- ___ 1000' Reel	1A-681- ___ 2500' Reel																		
1J-682- ___ 100' Bag	1B-682- ___ 500' Reel										1/4"	.170"	.040"	10	165 PSI	70 PSI	2.03	3/4"	PI, C
1A-682- ___ 1000' Reel	1J-683- ___ 100' Bag	3/8"	1/4"	.062"	10 10	165 PSI	70 PSI	4.72	1-1/4"	PI, C									
1A-683- ___ 500' Reel	1J-684- ___ 100' Bag																		
1A-684- ___ 250' Reel	1AA-684- ___ 500' Reel																		

Metric Sizes

Part Number & Color Code	Packaging Unit Size	OD mm	ID mm	Wall mm	Standard Colors	Working Pressure		lbs./100'	Bend Radius	Fitting
						75°F/25°C	150°F/65°C			
1J-692- ___ 100' Bag	1B-692- ___ 500' Reel	6	4	1	10	195 PSI	115 PSI	1.88	15.9 mm	PI, C
1A-692- ___ 1000' Reel										

Variations Available: Coiling • Colors • Cutting • Printing • Packaging • Sizes

Fluorinated Ethylene Propylene - FEP

Part Number & Color Code	Packaging Unit Size	OD	ID	Wall	Standard Colors	Working Pressure		lbs./100'	Bend Radius	Fitting									
						75°F/25°C													
1J-900- ___ 100' Bag	1C-900- ___ 500' Reel	1/8"	1/16"	.030"	10	420 PSI		0.9	1/2"	PI, C									
1B-900- ___ 1000' Reel	1A-900- ___ 2500' Reel																		
1J-901- ___ 100' Bag	1B-901- ___ 500' Reel										1/4"	3/16"	.030"	10	210 PSI		2.0	1.75"	PI, C
1A-901- ___ 3000' Reel	1J-902- ___ 100' Bag	1/4"	1/8"	.062"	10	455 PSI		3.4	1/2"	PI, C									
1A-902- ___ 1000' Reel	1J-903- ___ 100' Bag																		
1A-903- ___ 1000' Reel	1J-904- ___ 100' Bag	1/2"	3/8"	.062"	10	218 PSI		8.0	2"	PI, C									
1A-904- ___ 1000' Reel																			

Metric Sizes

Part Number & Color Code	Packaging Unit Size	OD mm	ID mm	Wall mm	Standard Colors	Working Pressure		lbs./100'	Bend Radius	Fitting									
						75°F/25°C													
1J-941- ___ 100' Bag	1C-941- ___ 500' Reel	4	2	1	10	450 PSI		1.4	1.5"	PI, C									
1B-941- ___ 1000' Reel	1A-941- ___ 2500' Reel																		
1J-942- ___ 100' Bag	1B-942- ___ 500' Reel										6	4	1	10	301 PSI		2.3	1"	PI, C
1A-942- ___ 2500' Reel	1J-943- ___ 100' Bag	8	6	1	10	225 PSI		3.2	2.5"	PI, C									
1A-943- ___ 1500' Reel	1J-944- ___ 100' Bag																		
1A-944- ___ 1500' Reel																			

Variations Available: Coiling • Colors • Cutting • Packaging • Jacketing

Spatter Guard SRT

Specifications

Temperature Range
-40°F to +165°F

Vacuum Rating
To 28" Hg.

Diameter Tolerances
±.005"

Hardness:
58D

Tube Markings
FW Specifications

Working Pressure
3:1 Safety Factor

Resin Compliance
Meets UL94V0

Suggested Fittings
Push-In & Compression

Spatter Guard SRT is made from a 94V0 polyurethane resin that has been specifically formulated to resist against weld spatter without the need of an outer jacket. While this new tubing can be used in any application where you are currently using the jacketed version, it has a higher working pressure making it even better suited for industrial applications. This resin resists oils, greases, heat-aging, ultra-violet light, and is silicone and halogen free. And because it is polyurethane, it is kink resistant, abrasion resistant, and it can also be bonded and formed into retractable coils. Spatter Guard SRT works with push to connect and compression fittings without the need for boots or skiving saving you time and money.

Features

- Protects tube from incidental weld spatter contact.
- No skiving necessary
- Resistant to kink damage.
- Broad range of chemical resistance.
- Can be formed into retractable coils.

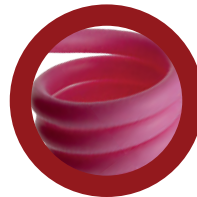

Spatter Guard SRT

Part Number & Color Code	Packaging Unit Size	OD	ID	Standard Colors	Working Pressure		lbs./100'	Bend Radius	Fitting
					75°F/25°C	150°F/65°C			
1J-376-___	100' Bag	5/32"	.093"	01 05 06 07	215 PSI	105 PSI	0.68	9/16"	PI,C
1C-376-___	500' Reel								
1B-376-___	1000' Reel								
1A-376-___	2500' Reel								
1J-371-___	100' Bag	1/4"	.160"	01 05 06 07	180 PSI	90 PSI	1.59	1"	PI,C
1B-371-___	250' Reel								
1A-371-___	1000' Reel								
1J-372-___	100' Bag	3/8"	.245"	01 05 06 07	170 PSI	85 PSI	3.48	1"	PI,C
1A-372-___	500' Reel								
1J-386-___	50' Bag	1/2"	.320"	01 05 06 07	170 PSI	80 PSI	6.37	1-1/8"	PI,C
1A-386-___	200' Reel								
Metric Sizes									
Part Number & Color Code	Packaging Unit Size	OD	ID	Standard Colors	Working Pressure		lbs./100'	Bend Radius	Fitting
					75°F/25°C	150°F/65°C			
1J-376-___	100' Bag	4	2.4	01 05 06 07	215 PSI	105 PSI	0.68	.562mm	PI,C
1C-376-___	500' Reel								
1B-376-___	1000' Reel								
1A-376-___	2500' Reel								
1J-398-___	100' Bag	6	4	01 05 06 07	160 PSI	80 PSI	1.34	25.4mm	PI,C
1B-398-___	250' Reel								
1A-398-___	1000' Reel								
1J-399-___	100' Bag	8	5	01 05 06 07	190 PSI	85 PSI	2.61	23.8mm	PI,C
1A-399-___	500' Reel								
1J-390-___	50' Bag	10	6.5	01 05 06 07	170 PSI	85 PSI	3.86	25.4mm	PI,C
1A-390-___	500' Reel								

Variations Available:

Coiling • Colors • Cutting • Bonding • Printing • Packaging

Weld Spatter Resistant Tubing

Weld-Spatter Resistant Tubing is made by taking blue Fre-Thane® 95A durometer polyurethane and jacketing it with a specially formulated weld-spatter resistant cover. The result is a jacketed tube that resists incidental weld spatter contact. The outer cover base resin meets UL94V0 requirements and offers strong insulating properties. It also resists oils, greases, acids, bases, aqueous solutions, ozone, heat-aging and ultraviolet light. The cover is approximately .030" thick and does not adhere to the inner tube, allowing the jacket to be easily skived back for fitting connection with conventional compression or push-in fittings.



Weld-Spatter Resistant

Features

- Protects tube from incidental weld spatter contact.
- Flexible with an excellent bend radius.
- Resistant to kink damage.
- Broad range of chemical resistance.
- Can be formed into retractable coils.

Specifications

Temperature Range
-40°F to +165°F

Vacuum Rating
To 28" Hg.

Diameter Tolerances
±.005"

Tube Markings
FW Specs

Working Pressure
3:1 Safety Factor

Resin Compliance
Outer Jacket: UL94V0
Inner Tube: UL94HB

Suggested Fittings
Push-In, Compression,
Barb

Weld-Spatter Resistant

Part Number & Color Code	Packaging Unit Size	OD	ID	Standard Colors	Working Pressure		lbs./100'	Bend Radius	Fitting
					75°F/25°C	150°F/65°C			
1J-356-07 _ 100' Bag									
1B-356-07 _ 500' Reel		5/32"	.093"	05 07	210 PSI	85 PSI	1.58	3/8"	PI, C B
1A-356-07 _ 1000' Reel									
1J-351-07 _ 100' Bag									
1B-351-07 _ 250' Reel		1/4"	.160"	01 05 06 07 08 11	175 PSI	70 PSI	2.89	1/2"	PI, C B
1A-351-07 _ 1000' Reel									
1J-352-07 _ 100' Bag		3/8"	.245"	01 07	170 PSI	70 PSI	5.25	7/8"	PI, C B
1A-352-07 _ 500' Reel									
1J-366-07 _ 50' Bag		1/2"	.320"	01	175 PSI	70 PSI	8.52	1-1/8"	PI, C B
1A-366-07 _ 200' Reel									

Part Number & Color Code	Packaging Unit Size	OD mm	ID mm	Standard Colors	Working Pressure		lbs./100'	Bend Radius	Fitting
					75°F/25°C	150°F/65°C			
1J-358-07 _ 100' Bag									
1B-358-07 _ 250' Reel		6	4	07	160 PSI	65 PSI	2.59	12.7 mm	PI, C B
1A-358-07 _ 1000' Reel									
1J-359-07 _ 100' Bag									
1A-359-07 _ 500' Reel		8	5	01 07 11	190 PSI	75 PSI	4.15	19 mm	PI, C B
1J-360-07 _ 100' Bag									
1A-360-07 _ 500' Reel		10	6.5	01 07	170 PSI	70 PSI	5.71	22.2 mm	PI, C B
1J-361-07 _ 50' Bag									
1A-361-07 _ 250' Reel		12	8	01	155 PSI	60 PSI	7.43	28.6 mm	PI, C B

Variations Available:

Coiling • Colors • Cutting • Bonding • Printing • Packaging

Also known as Spark-Lin®

US Toll Free: 888-373-9233

31

Static Dissipative Polyurethane

Specifications

Temperature Range
-40°F to +165°F

Vacuum Rating
To 28" Hg.

Diameter Tolerances
±.005"

Tube Markings
None

Dissipative Values:
per EIA Std 541

Volume Resistivity:
90A: 9.9×10^9 ohms-cm

Surface Resistivity:
90A: 9.9×10^9 ohms/sq

Working Pressure
3:1 Safety Factor

UV Stabilized
Yes

Suggested Fittings
Barb

Static electricity is a stationary charge of electricity resting on an object's surface. With plastic tubing, the charge is usually generated by friction on the exterior or interior of the tubing. The charge is typically localized. This means that a charge may exist on one part of the tube but not the entire tube. The spotty nature of the charge makes it much harder to detect. Furthermore, humans can only sense electrostatic discharge (ESD) greater than 3,500 electrostatic volts. A charge as low as 100 ESD volts can damage certain circuits meaning that electronics can be destroyed by ESD without the person even knowing it. For more information about ESD, please contact Freelin-Wade.

Freelin-Wade's Static Dissipative Polyurethane tubing is made from an Ether-based polyurethane that is specially formulated to help control ESD. It should always be used in low humidity environments or when tubing is going to be near circuit boards.

Features

- Dissipates electrostatic charges with no chemical additives.
- Contains no conductive fillers and no particle emission.
- Dissipative values are permanent and cannot be washed away.
- Non-contaminating and non-outgassing.
- Ideal for low humidity environments.
- Non-corrosive to electronic leads and components.

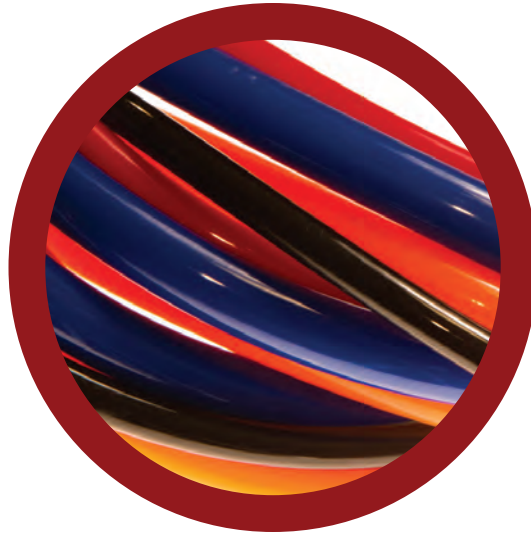

90A Static Dissipative Polyurethane

Part Number & Color Code	Packaging Unit Size	OD	ID	Wall	Standard Colors	Working Pressure		lbs./100'	Bend Radius	Fitting
						75°F/25°C	150°F/65°C			
1J-413-90 _ 100' Bag 1C-413-90 _ 500' Reel 1B-413-90 _ 1000' Reel 1A-413-90 _ 2500' Reel		1/8"	1/16"	.031"	01 81	145 PSI	55 PSI	.48	3/16"	B
1J-486-90 _ 100' Bag 1C-486-90 _ 500' Reel 1B-486-90 _ 1000' Reel 1A-486-90 _ 2500' Reel		5/32"	3/32"	.031"	01 02 05 07 09	125 PSI	50 PSI	.61	3/8"	B
1J-430-90 _ 100' Bag 1C-430-90 _ 500' Reel 1B-430-90 _ 1000' Reel 1A-430-90 _ 2500' Reel		5/32"	5/64"	.039"	01 04 07 09 81	145 PSI	60 PSI	.74	3/8"	B
1J-425-90 _ 100' Bag 1B-425-90 _ 500' Reel 1A-425-90 _ 1000' Reel		1/4"	1/8"	.062"	01 81	145 PSI	60 PSI	1.91	1/2"	B
1J-451-90 _ 100' Bag 1B-451-90 _ 500' Reel 1A-451-90 _ 1000' Reel		1/4"	.160"	.045"	07	115 PSI	60 PSI	1.46	3/4"	B
1J-452-90 _ 100' Bag 1A-452-90 _ 500' Reel		3/8"	.245"	.065"	05	100 PSI	50 PSI	3.18	1"	B

Part Number & Color Code	Packaging Unit Size	OD mm	ID mm	Wall mm	Standard Colors	Working Pressure		lbs./100'	Bend Radius	Fitting
						75°F/25°C	150°F/65°C			
1J-486-90 _ 100' Bag 1A-486-90 _ 2500' Reel		4	2.4	.8	01 02 05 07 09	105 PSI	50 PSI	.80	9.5 mm	B
1J-488-90 _ 100' Bag 1B-488-90 _ 500' Reel 1A-488-90 _ 1000' Reel		6	4	1	01 07 09 81	90 PSI	45 PSI	1.3	12.7 mm	B
1J-489-90 _ 100' Bag 1A-489-90 _ 500' Reel		8	5	1.5	01 07	100 PSI	50 PSI	2.6	19 mm	B
1J-490-90 _ 50' Bag 1A-490-90 _ 500' Reel		10	6.5	1.75	05 07	100 PSI	50 PSI	3.9	22.3 mm	B
1J-491-90 _ 50' Bag 1A-491-90 _ 250' Reel		12	8	2	01	90 PSI	45 PSI	5.3	28.6 mm	B

Variations Available:

Coiling • Colors • Cutting • Bonding • Printing • Packaging

Reinforced PUR, Flexi-Corr™ & Asepsi-Flex®

Specifications

Temperature Range

Reinforced PUR
-40°F to +165°F

Flexi-Corr
-20°F to +160°F

Asepsi-Flex
-30°F to +150°F

Vacuum Rating
To 28" Hg.

Diameter Tolerances

Reinforced PUR
±.005"

Working Pressure

Reinforced PUR
4:1 Safety Factor

UV Stabilized

Reinforced PUR
Yes

Flexi-Corr Yes

Resin Compliance

Reinforced PUR

NSF61, USFVI,
Meets UL94HB

Flexi-Corr FDA

Reinforced PUR is a clear, heavy-wall, 85A durometer polyurethane hose reinforced with a tough nylon innerbraid. The reinforcement provides a greater working pressure while maintaining flexibility and kink resistance. The Ether-based compound is ideal for transferring abrasive materials or media that would be damaging to PVC and other hoses.

Features

- Resistant to abrasion, oils, and fungus.
- Tough; withstands constant flexing.
- Light weight.
- Very flexible in subzero temperatures.
- Bondable into multi-ribbon hoses.
- Retains original values; does not harden or crack with age.

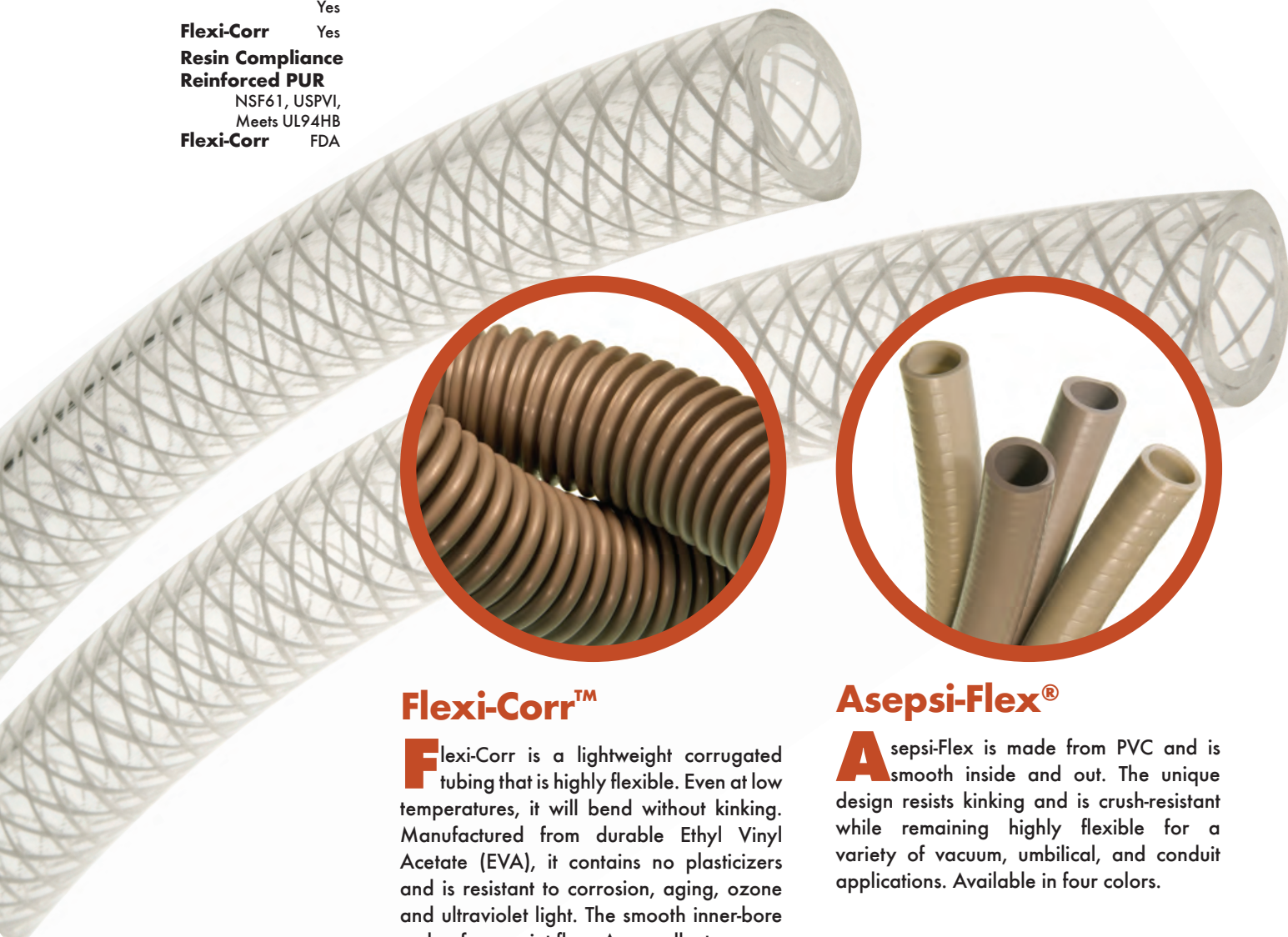

Flexi-Corr™

Flexi-Corr is a lightweight corrugated tubing that is highly flexible. Even at low temperatures, it will bend without kinking. Manufactured from durable Ethyl Vinyl Acetate (EVA), it contains no plasticizers and is resistant to corrosion, aging, ozone and ultraviolet light. The smooth inner-bore makes for a quiet flow. An excellent vacuum and low pressure blower tubing, it's also commonly used as a conduit for bundling assortments of tubing and wiring.

Asepsi-Flex®

Asepsi-Flex is made from PVC and is smooth inside and out. The unique design resists kinking and is crush-resistant while remaining highly flexible for a variety of vacuum, umbilical, and conduit applications. Available in four colors.

Reinforced PUR Hose

Part Number & Color Code	Packaging Unit Size	OD	ID	Wall	Available Only in Clear	Working Pressure		lbs./100'	Bend Radius	Fitting
						75°F/25°C	150°F/65°C			
1A-800-10	100' Reel	.470"	1/4"	.110"	10	230 PSI	150 PSI	6.0	3/4"	B
1E-800-10	Cut Length									
1A-801-10	100' Reel	.630"	3/8"	.127"	10	155 PSI	100 PSI	9.9	1-1/2"	B
1E-801-10	Cut Length									
1A-802-10	100' Reel	.750"	1/2"	.125"	10	125 PSI	80 PSI	12.0	2"	B
1E-802-10	Cut Length									
1A-803-10	100' Reel	.905"	5/8"	.140"	10	105 PSI	70 PSI	16.4	2-3/4"	B
1E-803-10	Cut Length									
1A-804-10	100' Reel	1.025"	3/4"	.137"	10	90 PSI	60 PSI	18.6	3"	B
1E-804-10	Cut Length									
1A-805-10	100' Reel	1.300"	1"	.150"	10	75 PSI	50 PSI	26.2	5"	B
1E-805-10	Cut Length									

Variations Available: Coiling • Cutting • Bonding • Printing • Packaging • Sizes

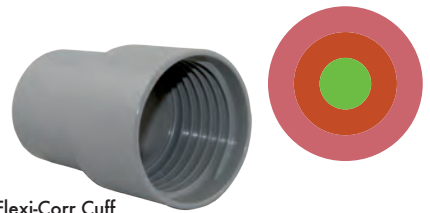
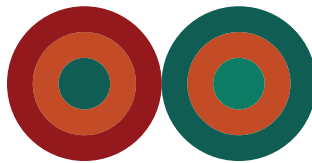

Flexi-Corr Cuff

Flexi-Corr™ Corrugated Hose

Part Number & Color Code	Packaging Unit Size	ID	Standard Colors	Working Pressure 75°F/25°C	lbs./100'	Max Vacuum	Part Number for Cuffs
1E-047- ___	25' Length	1/2"	04 54 72 92	15 PSI	6.8	29 Hg	0C-012
1F-047- ___	50' Length						
1E-053- ___	25' Length	5/8"	04 54 72 92	15 PSI	8.7	29 Hg	0C-058
1F-053- ___	50 Length						
1E-054- ___	25' Length	3/4"	04 54 72 92	15 PSI	10.0	29 Hg	0C-034
1F-054- ___	50' Length						
1E-055- ___	25' Length	1"	04 54 72 92	15 PSI	14.0	29 Hg	0C-100
1F-055- ___	50' Length						
1E-056- ___	25' Length	1-1/4"	04 54 72 92	13 PSI	20.0	29 Hg	0C-114
1F-056- ___	50' Length						
1E-057- ___	25' Length	1-1/2"	04 54 72 92	9 PSI	26.0	29 Hg	0CH-112
1F-057- ___	50' Length						
1E-058- ___	25' Length	1-3/4"	04 54 72 92	7 PSI	34.0	28 Hg	N/A
1F-058- ___	50' Length						
1E-093- ___	25' Length	2"	04 54 72 92	5 PSI	52.0	20 Hg	0C-200
1F-093- ___	50' Length						

Cutting • Packaging

Asepsi-Flex® PVC Vacuum Hose

Part Number & Color Code	Packaging Unit Size	ID	Standard Colors	Maximum Vacuum
1E-501- ___	25' Length	1/2"	14 54 72 92	29 Hg.
1F-501- ___	100' Length			
1E-625- ___	25' Length	5/8"	14 54 92	29 Hg.
1F-625- ___	100' Length			

Cutting • Packaging

US Toll Free: 888-373-9233

Jacketing & Accessories



PVC Jacketed Bundles

Freelin-Wade's PVC Jacketed Bundles are an excellent way to color code a pneumatic system in a neat flexible package. Jacketing your tubing lines is an attractive and easy way to organize your tubing. It saves time over tie wrapping and creates a more user friendly assembly.

Expandable Webbing

Expandable Webbing can expand up to three times its size. The webbing is a polyester sleeve that allows heat and humidity to escape. Expandable Webbing is flexible and easy to install. Available only in black.



Part Number	Packaging Unit Size	Minimum Size	lbs./100'
1J-126-01	25' Bag		
1D-126-01	100' Box	1/4"	.2
1B-126-01	500' Reel		
1J-127-01	25' Bag		
1D-127-01	100' Box	1/2"	.8
1B-127-01	500' Reel		
1J-128-01	25' Bag		
1D-128-01	100' Box	3/4"	1.2
1B-128-01	250' Reel		

Spiral Wrap

Spiral Wrap is made from a spiral cut of linear low density polyethylene (LLDPE) material. It easily wraps around tubing and allows for easy branching of contents.



Part Number	Packaging Unit Size	OD	ID	Standard Colors	lbs./100'
1J-078-___	25' Bag				
1D-078-___	100' Box	1/2"	3/8"		3.4
1A-078-	250' Reel				

Tubing Cutters & Replacement Blades

Suitable for 1/8" - 3/4" O.D. tubing. Keep one everywhere that you have tubing.



Tubing Cutter Part Number	Description
PXC058	Black Tubing Cutter
PXC058B	Blue Tubing Cutter
PXC058-L	Black Tubing Cutter w/Red Leash

Replacement Blades Part Number	Description
PXC059	Single Blade
PXC059-P5	5-Pack
PXC059-P10	10-Pack

Jacketing & Accessories



Hose Cutter

Our heavy duty Hose Cutter will cut plastic tubing or hose up to 1" O.D. Reinforced hose can be cut perfectly with ease.

Hose Cutter Part Number	Description
PXC098R	Red Hose Cutter
PXC099M	Single Replacement Blade



Tubing H Clips

Our "H" Clips are an easy and inexpensive way to route dual tubing or hose runs. Conveniently attached via the countersunk center screw hole (3/16"). Tubing "H" Clips neatly and safely secure tubing for a clean professional look. Manufactured from black Polyacetal plastic with a useful temperature range of -40° to + 212°F.

"H" Clip Part Number	Fits Tubing Size	"H" Clip Part Number	Fits Tubing Size
HTC-156-200	.156" - .200"	HTC-486-575	.486" - .575"
HTC-201-325	.201" - .325"	HTC-576-675	.576" - .675"
HTC-326-400	.326" - .400"	HTC-676-825	.676" - .825"
HTC-401-485	.401" - .485"	HTC-826-1000	.826" - 1.00"



Tube Channels

Our tube channel mounts are perfect for securing multiple tubing lines. The small 10-tube channel can be mounted with its pressure sensitive adhesive backing or with a #4 screw. Available in three sizes to fit 5/32", 3/16" and 1/4" tubing. The large style channel holds 3/8" and 1/2" tubing and mounts with two screws.

Large Channel Part Number	Tubing Size OD	Number of Channels	Small Channel Part Number	Tubing Size OD	Number of Channels
PTC6-7	3/8	7	TC5-10	5/32	10
PTC6-10	3/8	10	TC3-10	3/16	10
PTC8-6	1/2	6	TC4-10	1/4	10

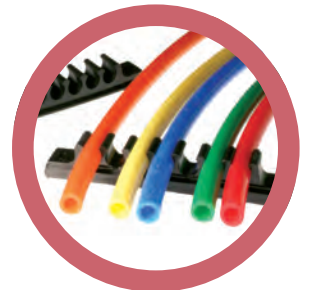

Resource Guide—Chemical Resistance Chart

This information was provided to Freelin-Wade by our suppliers and other sources. It is to be used only as a general reference guide to aid in the selection of products in which chemical and material compatibility issues are a factor. This guide is not intended as a complete nor conclusive database. Freelin-Wade does not guarantee these ratings since the resistance of a material can be greatly affected by the temperature, consistency, and presence of other chemicals. Ultimately, the consumer must determine the chemical compatibility of an item based on the conditions in which the product is being used.

Rating Scale

- 1 = Little or no impact
- 2 = Minor effect
- 3 = Moderate effect
- 4 = Severe effect

	PUR	PE	PVC	Nylon	Kynar
Acetic Acid, Glacial	4	2	4	-	1
Acetic Acid, 30%	4	1	4	2	1
Acetone	4	2	4	1	4
Acetylene	1	4	1	1	1
Alkazine	4	-	-	-	-
Aluminum Chloride (aq)	3	2	1	-	1
Aluminum Nitrate (aq)	3	-	2	-	1
Ammonia Anhydrous	4	2	1	-	4
Ammonia Gas (cold)	3	-	3	1	4
Ammonia Gas (hot)	4	-	-	1	4
Ammonium Chloride (aq) 40%	2	1	1	-	1
Ammonium Sulfate (aq)	1	1	1	1	1
Amyl Alcohol	4	2	1	-	1
Amyl Naphthalene	4	-	-	-	-
Animal Fats	1	-	-	-	-
Aqua Regia	4	2	3	-	-
Arsenic Acid	3	2	1	-	1
Asphalt	2	1	1	-	1
ASTM Fuel A	2	-	-	-	-
ASTM Fuel B	3	-	-	-	-
ASTM Fuel C	3	1	4	-	-
Barium Chloride (aq)	1	2	1	1	1
Beer	2	2	1	1	1
Beet Sugar Liquors	4	1	1	-	1
Benzene	3	4	3	1	1
Benzine	2	-	-	-	-
Blast Furnace Gas	4	-	-	-	-
Bleach Solutions	4	1	1	-	1
Borax	1	1	1	-	1
Boric Acid	1	1	1	-	1
Brake Fluid	4	-	-	-	1
Brine	2	-	3	-	1
Bromine Water	4	-	3	4	1
Bunker Oil	2	-	-	-	-
Butane	1	3	3	1	1
Butter	1	-	-	-	-
Butyl Alcohol (Butanol)	3	1	3	1	1
Butylene	4	1	1	-	1
Calcium Chloride (aq)	1	1	3	1	1
Calcium Hydroxide (aq)	2	1	2	-	1
Calcium Nitrate (aq)	1	-	1	1	1
Calcium Sulfide (aq)	1	-	-	-	-
Cane Sugar Liquors	4	-	1	-	1
Carbolic Acid	3	4	3	-	-
Carbon Dioxide	1	2	1	-	1
Carbonic Acid	4	2	1	-	1
Carbon Monoxide	1	2	1	-	1
Carbon Tetrachloride	4	4	4	3	1
Castor Oil	1	1	1	-	1
Chlorine (dry)	4	3	4	4	1
Chlorine (wet)	4	3	-	4	1
Chloroform	4	4	4	3	1
Chlorox	4	-	-	-	-
Chromic Acid 50%	4	1	4	4	1
Citric Acid	1	1	2	1	1
Coal Tar (Creosote)	3	-	-	-	-
Coconut Oil	2	1	1	-	1
Cod Liver Oil	1	1	1	-	-
Coke Oven Gas	4	-	-	-	-
Copper Chloride (aq)	1	2	1	-	1
Copper Cyanide (aq)	1	2	1	-	1
Corn Oil	1	1	2	-	1
Cotton Seed Oil	1	1	2	-	1
Creosol (Methyl Phenol)	4	4	4	4	1
Cyclohexane	1	4	4	1	1
Denatured Alcohol	4	-	-	-	-
Detergent Solution	3	1	1	-	-
Diesel Oil	2	3	1	-	-
Dioxane	4	3	-	-	4
Dowtherm Oil	3	-	-	-	-
Dry Cleaning Fluids	4	-	-	-	-
Ethane	1	-	1	-	-
Ethyl Acrylate	4	-	-	-	1
Ethyl Alcohol (Ethanol)	4	2	3	3	1
Ethyl Benzene	4	-	-	-	-
Ethyl Cellulose	2	-	-	-	-
Ethyl Chloride	4	4	4	-	1
Ethyl Ether	3	4	4	-	1
Ethylene Chloride	4	4	4	-	-
Ethylene Glycol (Anti-Freeze)	2	1	1	1	1
Ethylene Oxide	4	3	3	1	1
Ethylene Trichloride	4	4	-	-	-
Ferric Chloride (aq)	1	2	1	-	1
Ferric Nitrate (aq)	1	2	1	-	1
Ferric Sulfate (aq)	2	1	1	-	1
Fluorine (Liquid)	4	3	4	4	1
Formaldehyde (RT)	4	2	1	1	1
Formic Acid	4	2	1	4	1
Freon 11	4	3	1	-	-
Freon 12	1	1	1	1	-
Freon 22	4	-	1	1	-
Fuel Oil (Bunker 'C')	2	3	1	-	1
Gasoline (100 Octane, High Test)	3	4	3	1	1
Glue	1	1	3	-	1
Glycerin (Glycerol)	1	1	1	1	1
Glycols	4	-	-	1	-
Green Sulfate Liquor	1	-	-	-	-
Hexane	2	4 ¹	2 ²	-	1
Hydraulic Oil	1	1-3	1	-	-
Hydrochloric Acid (cold) 37%	4	2	2	4	1
Hydrochloric Acid (hot) 37%	4	-	-	4	1
Hydrofluoric Acid (Conc.) (cold)	4	2	-	-	1
Hydrofluoric Acid (Conc.) (hot)	4	-	-	-	1
Hydrogen Gas	1	1	1	1	1
Isobutyl Alcohol	3	1	-	-	1
Isocetane	2	3	1	-	1
Isopropyl Acetate	4	3	4	-	-
Isopropyl Alcohol (Isopropanol)	3	1	-	1	1
Isopropyl Ether	2	1	2	-	1
Kerosene	1	4	2	1	1

	PUR	PE	PVC	Nylon	Kynar
Lacquers	4	1	4	-	-
Lacquer Solvents	4	1	3	-	-
Lard	1	1	1	-	1
Lavender Oil	4	-	-	-	-
Lead Acetate (aq)	4	1	1	-	1
Linseed Oil	2	3	1	1	1
Liquid Petroleum Gas	1	-	-	1	-
Lubricating Oils	1-2 ³	4	2	1	1
Lye	4	1-4 ⁴	1-2	-	-
Magnesium Chloride (aq)	1	2	1	1	1
Magnesium Hydroxide (aq)	4	2	1	-	1
Mercury	1	1	1	1	1
Methane	3	-	2	1	1
Methyl Acetate	4	2	4	1	1
Methyl Acrylate	4	-	-	-	1
Methyl Alcohol (Methanol)	4	1	1	1	1
Methyl Butyl Ketone	4	-	1	-	-
Methyl Chloride	4	4	4	1	1
Methylene Chloride	4	4	4	-	1
Methyl Ethyl Ketone	4	2	4	1	4
Methyl Isobutyl Ketone	4	3	4	1	4
Milk	4	1	1	1	1
Mineral Oil	1	3	1	1	1
Motor Oil 20W, 10W40	2	3	2	1	1
Naphtha (Lighter Fluid)	2	4	1	1	1
Naphthalene (Moth Repellent)	2	2	4	1	1
Natural Gas	2	-	1	-	1
Neatsfoot Oil	1	-	-	-	-
Nitric Acid 70%	4	2	-	4	1
Nitric Acid (Dilute) 10%	3	2	1	4	1
Nitroethane	4	-	-	-	1
N-Octane	4	1	-	-	1
Oleic Acid	2	1	3	1	1
Oleum Spirits	3	4	4	-	4
Olive Oil	1	1	-	-	1
Oxygen (cold)	1	-	-	1	1
Oxygen (200-400F)	4	-	-	-	-
Paint Thinner, Duco	4	-	-	-	-
Perchloric Acid	4	1	3	-	1
Perchloroethylene	4	4	3	3	1
Petroleum - Below 250F	2	3	-	-	1
Petroleum - Above 250F	4	-	-	-	-
Phenol (Carbolic Acid)	3	2	3-4	4	1
Phenyl Ethyl Ether	4	-	-	-	-
Phosphoric Acid - 45%	4	1	2	2	1
Pickling Solution	4	-	-	-	-
Picric Acid	2	1	4	3	1
Potassium Acetate (aq)	4	-	-	-	1
Potassium Chloride (aq)	1	2	1	-	1
Potassium Cyanide (aq)	1	2	1	-	1
Potassium Hydroxide (aq)	4	1	1	3	4
Producer Gas	1	1	1	-	-
Propane	1	4	1	1	1
Propyl Alcohol (Propanol)	4	1	1	-	1
Propylene	4	-	2	-	-
Propylene Glycol (Anti-Freeze)	3	1	3	2	1
Propylene Oxide	4	2	-	-	4
Pydraul, 10E, 29 ELT	4	-	-	-	-
Pydraul 30E, 50E, 65E	4	-	-	-	-
Pydraul, 115E	4	-	-	-	-
Pydraul 230E, 312C, 540C	4	-	-	-	-
Repsesed Oil	2	4	-	-	-
R-11 (MILF-23338 B)	1	-	-	-	-
R-11 (MILF-25576 C)	1	-	-	-	-
Salt Water	2	1	1	1	1
Sewage	1	-	-	-	1
Silicate Esters	1	-	-	-	-
Silicone Oils	1	1	1	-	1
Silver Nitrate	1	1	1	-	1
Skydrol 500	4	-	-	-	-
Skydrol 700	4	-	-	-	-
Soap Solutions	3	4	1	1	-
Sodium Chloride (aq)	1	1	1	1	-
Sodium Hydroxide (aq)	4	1	1	2	4
Sodium Peroxide (aq)	4	1	2	-	1
Sodium Phosphate (aq)	1	-	-	-	1
Sodium Sulfate (aq)	1	1	1	-	-
Soy Bean Oil	2	1	1	-	1
Stoddard Solvent	1	3	3	-	-
Styrene (Monomer)	4	-	4	1	1
Sucrose Solution	4	2	-	-	-
Sulfuric Acid (Dilute Battery Acid)	3	1	1	-	1
Sulfuric Acid (Conc)	4	2	4	-	1
Sulfuric Acid (20% Oleum)	4	-	4	-	4
Sulfurous Acid	4	2	1	-	-
Tannic Acid	4	1	1	-	1
Tetrachlorethylene	4	2	4	-	-
Toluene (Toluol)	4	3	4	1	1
Transformer Oil	2	-	2	-	-
Transmission Fluid Type A	2	-	-	-	-
Trichloroethane	4	4	3	3	1
Trichloroethylene	4	4	4	3	1
Turbine Oil	1	3	1	1	-
Turpentine	4	4	4	1	1
Varnish	3	3	4	-	1
Vinegar	2	1	1	1	1
Vinyl Chloride	4	4	4	-	1
Water	1	1	1	1	1
Whiskey, Wines	2	1	1	1	1
White Oil	1	-	-	-	-
Wood Oil	3	-	-	-	-
Xylene	4	4	4	1	1
Zinc Acetate (aq)	4	-	-	-	1
Zinc Chloride (aq)	2	1	1	1	1

- 1 Petroleum Base 2 Synthetic Base = 1, Petroleum Base = 3
- 3 SAE 10, 20, 30, 40, 50 = 1, Petroleum = 2
- 4 Calcium Hydroxide & Potassium (Hydroxide=1, Sodium Hydroxide=4) 5 See Propylene Glycol 6 See Ethylene Glycol

Part Number Index & Tubing Pressure Guide

Part Number	Page	Part Number	Page	Part Number	Page	Part Number	Page	Part Number	Page	Part Number	Page
1A-005-	10	1A-491-90-	33	1C-134-	10	1J-075-	21	1J-36_-07	31	3J-028-	11
1A-013-	10	1A-68_-	29	1C-15_-	9	1J-076-	20	1J-37_-	30	4A-023-	11
1A-015-	10	1A-69_-	29	1C-171-	9	1J-077-	20	1J-38_-	30	4A-026-	11
1A-025-	10	1A-70_-10	19	1C-189-	20	1J-078-	36	1J-39_-	30	4J-023-	11
1A-030-	10	1A-72_-10	19	1C-20_-	23	1J-107-	9	1J-413-90-	33	4J-026-	11
1A-045-	10	1A-80_-10	35	1C-22_-	24	1J-109-	20	1J-425-90-	33	4M_-	12/13
1A-048-	20	1A-90_-10	29	1C-246_-	23	1J-111-	10	1J-430-90-	33	4ME_-	12/13
1A-071-	21	1A-94_-10	29	1C-26-	25	1J-12_-01	36	1J-451-90-	33	4W-023-	11
1A-072-	21	1A-96_-10	21	1C-413-90-	33	1J-132-	10	1J-452-90-	33	6M_-	12/13
1A-073-	21	1AA-075-	21	1C-430-90-	33	1J-133-	10	1J-486-90-	33	6ME_-	12/13
1A-074-	20	1AA-076-	20	1C-486-90-	33	1J-134-	10	1J-488-90-	33	8M_-	12/13
1A-075-	21	1AA-086-	20	1C-68_-	29	1J-149-	10	1J-489-90-	33	8ME_-	12/13
1A-076-	20	1AA-207-	23	1C-900-10	29	1J-151-	9	1J-490-90-	33	HTC_-	37
1A-077-	20	1AA-213-	23	1C-94_-10	29	1J-152-	9	1J-491-90-	33	N106_-	27
1A-078-	36	1AA-245-	23	1C-96_-	21	1J-153-	10	1J-68_-	29	N12_-	26
1A-086-	20	1AA-267-	25	1D-025-	10	1J-156-	9	1J-69_-	29	N14_-	26
1A-107-	9	1AA-275-	25	1D-078-	36	1J-157-	9	1J-7_-10	19	N17_-	27
1A-109-	20	1AA-284-10	25	1D-12_-01	36	1J-158-	9	1J-90_-10	29	N38_-	26
1A-111-	10	1AA-684-10	29	1E-0_-	35	1J-159-	9	1J-94_-10	29	PFE_-	14
1A-132-	10	1B-005-	10	1E-176-	9	1J-160-	9	1J-96_-	21	PR_-	17
1A-133-	10	1B-013-	10	1E-501-	35	1J-161-	9	1L-013-	10	PRE_-	15
1A-134-	10	1B-025-	10	1E-625-	35	1J-162-	9	1L-109-	20	PTC_-	37
1A-149-	10	1B-030-	10	1E-80_-	35	1J-163-	9	1L-157-	9	PU_-	16
1A-151-	9	1B-045-	10	1F-0_-	35	1J-166-	9	1L-189-	20	PUE_-	15
1A-152-	9	1B-048-	12	1F-501-	35	1J-169-	9	1W_-	18	PXC_-	36/37
1A-153-	10	1B-68_-	29	1F-625-	35	1J-170-	10	1X_-	18	TC_-	37
1A-156-	9	1B-071-	21	1J-005-	10	1J-171-	9	1Y_-	18		
1A-157-	9	1B-107-	9	1J-013-	10	1J-189-	20	1Z_-	18		
1A-158-	9	1B-109-	20	1J-015-	10	1J-194-	10	2A_-	11		
1A-159-	9	1B-126-01	36	1J-025-	10	1J-20_-	23	2B-006-	11		
1A-160-	9	1B-127-01	36	1J-030-	10	1J-21_-	23	2J_-	11		
1A-161-	9	1B-128-01	36	1J-045-	10	1J-22_-	24	2M_-	12/13		
1A-162-	9	1B-132-	10	1J-048-	20	1J-24_-	23	2MC-	13		
1A-163-	9	1B-133-	10	1J-071-	21	1J-26_-	25	2ME-	12/13		
1A-166-	9	1B-15_-	9	1J-072-	21	1J-27_-	25	2V-006-	11		
1A-169-	9	1B-169-	9	1J-073-	21	1J-28_-10	25	2W-016-	11		
1A-170-	10	1B-171-	9	1J-074-	20	1J-35_-07	31	3A-028-	11		
1A-171-	9	1B-189-	20								
1A-176-	9	1B-194-	10								
1A-189-	20	1B-20_-	23								
1A-194-	10	1B-22_-	24								
1A-20_-	23	1B-24_-	23								
1A-214-	23	1B-26_-	25								
1A-22_-	24	1B-27_-	25								
1A-24_-	23	1B-28_-10	25								
1A-26_-	25	1B-35_-07	31								
1A-27_-	25	1B-37_-	30								
1A-28_-	25	1B-39_-	30								
1A-35_-07	31	1B-413-90-	33								
1A-36_-07	31	1B-425-90-	33								
1A-37_-	30	1B-430-90-	33								
1A-38_-	30	1B-451-90-	33								
1A-39_-	30	1B-486-90-	33								
1A-413-90-	33	1B-488-90-	33								
1A-425-90-	33	1B-68_-	29								
1A-430-90-	33	1B-69_-	29								
1A-451-90-	33	1B-90_-10	29								
1A-452-90-	33	1B-94_-10	29								
1A-486-90-	33	1B-96_-10	21								
1A-488-90-	33	1C-013-	10								
1A-489-90-	33	1C-030-	10								
1A-490-90-	33	1C-109-	20								

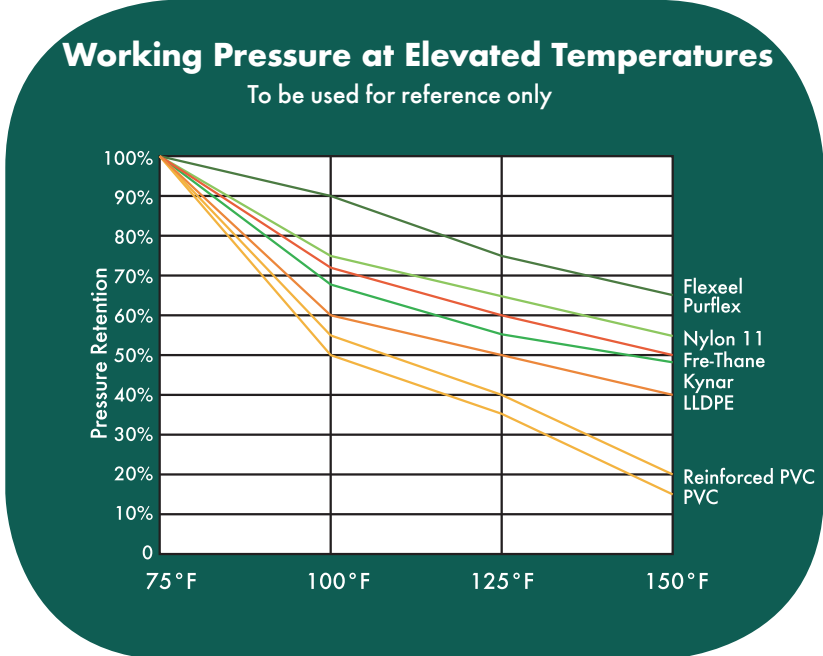

Doing everything we can to say "YES" to your tubing needs

For more than 38 years our customers have looked to Freelin-Wade to solve their specific tubing requirements. We manufacture and stock more than 4,000 tubing products made from polyurethane, nylon, LLDPE, PVC and many other plastic resins. Many options are FDA, USPVI, NSF51 and/or NSF61 compliant. Much of our business is comprised of taking this stock tubing and adapting it to meet our customers' needs. We call these "Variations." Variations can come in many forms including:

- Assembly
- Bonding
- Coiling
- Colors
- Cutting
- Forming
- Jacketing
- Packaging
- Printing
- Sizes

We provide design expertise and rapid prototyping options. We set the industry standard for tubing that fits and arrives on time.



1730 NE Miller Street
McMinnville, Oregon 97128
United States of America
888-373-9233
www.freelin-wade.com